

Enterprise Blown Fiber Solutions

MicroDuct Systems | eABF Cables | Connectivity
OSP MicroCore® Cables | Test & Inspection | Fusion Splicers



Founded in 1984, AFL is an international manufacturer providing end-to-end solutions to the energy, service provider, enterprise, hyperscale and industrial markets.

AFL's products are in use in over 130 countries and include fiber optic cable and hardware, transmission and substation accessories, outside plant equipment, connectivity, test and inspection equipment, fusion splicing systems and training.

AFL also offers a wide variety of services supporting data center, enterprise, wireless and outside plant applications.

Headquartered in Spartanburg, SC, AFL has operations in the U.S., Mexico, Canada, Europe, Asia and Australia, and is a wholly owned subsidiary of Fujikura Ltd. of Japan.

AFL is dedicated to bringing our customers a quality product as well as delivering superior value.



Dura-Line is an Orbia Connectivity Solutions business and is the premier provider of innovative pathway solutions for global and communications and infrastructure needs.

As a leading global manufacturer and distributor of communication and energy infrastructure products and systems, Dura-Line sets the industry standard in its approach to solution-based development of products for conduit, MicroDucts and accessories.

Dura-Line's products are designed to provide both protection and ease of installation of communication networks, power cables and pressure pipe for a wide variety of markets, including telecommunications, enterprise networking and transportation.

Dura-Line has 21 manufacturing facilities located throughout the U.S., Canada, Asia, South America, and Europe.



Table of Contents

- eABF® Solutions. 2
- eABF® Products 3
- Lifetime Warranty on End-to-End Fiber Optic Systems. 4

Dura-Line Products

- Enterprise FuturePath Family. 5
- Enterprise FuturePath MicroDuct System 7
- Enterprise FuturePath Family. 7
- MicroDuct Distribution Box. 11
- MicroDuct Organizer 11
- MDS Enclosure 12
- Accessories 14
- Enterprise Blown Fiber (eABF®) Cable 16
- eABF® SWR® Enterprise Blown Fiber Cable 19
- Hybrid Enterprise Blown Fiber (eABF) Cable
with Various Fiber Configurations 21

AFL Products

Fiber Optic Cable

- LM-Series OSP MicroCore® Cable 22
- LM200-Series OSP MicroCore® Cable 24

Fiber Inside Plant

- Connector Specifications 26
- Simplex Cable Assemblies. 27
- Duplex Cable Assemblies 28
- LC Uniboot Cable Assemblies 29
- Multi-Fiber Cable Assemblies 30
- MPO Cable Assemblies 32
- Xpress Fiber Management® (XFM®) 1RU Patch Panel. 34
- Xpress Fiber Management® (XFM®) 2RU Patch Panel. 35
- Xpress Fiber Management® (XFM®) 4RU Patch Panel. 36
- XFM®-28 Dual Access Module Panel 37
- LightLink Adapter Plates. 38
- Poli-MOD® Patch and Splice Module 41
- FASTConnect® Field-Installable Connectors 43
- FASTConnect® Universal Tool Kit. 45
- FUSEConnect® Field-Installable Connectors 46
- FUSEConnect® MPO Splice-On, Field-Installable Connectors
with Heat Sleeve 48

Fiber Outside Plant

- LightLink 580 Optical Splicing and Distribution Enclosure 50
- LightLink 550 Optical Splicing and Distribution Enclosure 52

Test and Inspection

- FlexScan® FS200 Single-mode OTDR. 54
- FOCIS Flex – Fiber Optic Connector Inspection System 60
- Optical Loss Test Kits 64
- VFI4 Visual Fault Identifiers. 68

Fusion Splicers

- Fujikura 90S+ Fusion Splicer. 70
- Fujikura 45S Fusion Splicer **NEW** 73
- SpliceConnect with Tool Kit. 77

- eABF Solutions 78
- eABF Applications Map Inside Back Cover

eABF® Fiber Optic Cable



eABF® Fiber Optic Cable

eABF® Solutions

eABF Cable

At the heart of the eABF solution is the cable and the duct. The eABF cable has been designed to offer exceptional air-jetting qualities yet rugged enough to comply with Telcordia’s GR-409 Premise Cabling standard and NEC Riser and Plenum flame ratings even outside of the MicroDuct. As a result, the cable can be deployed once exiting the pathway without the need for additional costly furcation tubing as required by other less robust alternatives. The cable is available in fiber counts from six through 144 with all fiber types including SMF, OM2, OM3 and OM4, and employs bend-insensitive fiber technology.

eABF MicroDuct

The eABF pathway system is comprised of Enterprise FuturePath® MicroDuct products engineered and produced by Dura-Line, the premier communications-oriented fiber optic duct system. The eABF duct options include indoor/outdoor riser, plenum, low-smoke zero halogen (LSZH) and HDPE product lines. All eABF ducts incorporate low-contact ribbed inner surface and ultra-low friction SILICORE®. The eABF FuturePath MicroDuct comes in tube counts from two through 24.

System

AFL and Dura-Line have joined together to produce a high-performance blown fiber optic cabling system with applications across a broad spectrum of networking configurations. The solution, eABF (Enterprise Blown Fiber) cabling system is engineered to offer a reliable, easy-to-install optical fiber network communications infrastructure that has one of the highest fiber density solutions in the blown fiber market. The eABF solution has all the key elements that, when combined, yield a state-of-the-art and highly flexible “living” communications pathway.

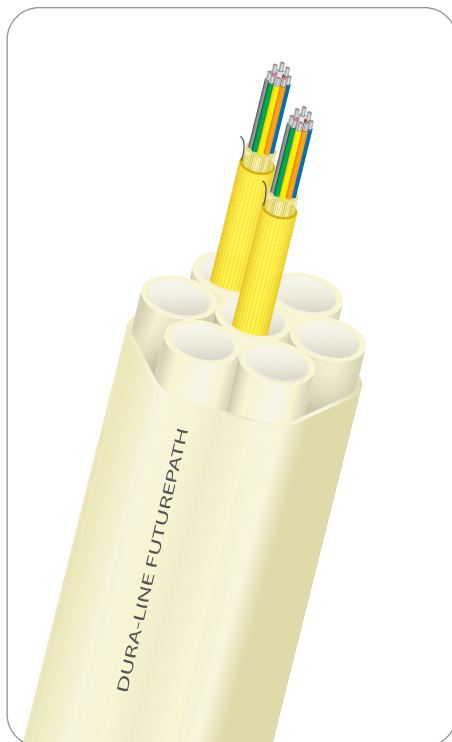

- AFL eABF Cables
- Dura-Line Enterprise FuturePath MicroDuct
- AFL Connectivity
- AFL Test Equipment and Fusion Splicers
- ACE Lifetime* Warranty
- Design, BOM and SOW Support
- Contractor Training and Project Management

*Lifetime is defined as the System Design Lifetime which is 25 years.

eABF Solutions

CABLES	
	<p>Enterprise Blown Cable (6-144 fibers)</p> <p>Specifically designed for air-jetting applications through MicroDuct pathways. The proprietary high-drag, light-weight design yields a cable that performs well during installation and yet offers a very robust and compact package for direct routing through congested point-of-termination cable management locations. These cables are GR-409 compliant and come in OFNP and OFNR ratings.</p>
	<p>Enterprise Blown OSP MicroCore® Cable (LM Series)</p> <p>Available in fiber counts up to 432 in blowable and pullable designs. Stranded buffer tubes simplify splicing/handling and allow for mid-span access to the fibers. The AFL OSP MicroCore series includes one of the industry's highest fiber densities yet maintains a minimum 300-lb load rating for installation.</p>
MICRODUCT SYSTEMS	
	<p>Enterprise FuturePath</p> <p>Enterprise FuturePath is available in many sizes and configurations including riser, plenum and LSZH. MicroDuct sizes include 12.7 mm and 8.5 mm to accommodate your fiber requirements. Configurations from single MicroDucts to 24 pathways allow for rapid deployment of fiber today with permanent pathways in place for future growth.</p>
	<p>OSP FuturePath</p> <p>OSP FuturePath is available in many sizes and configurations for outside plant network installations. The same broad range of MicroDuct options found in the Enterprise products plus a large range of inner duct sizes are available. All FuturePath products come in armored and non-armored designs.</p>
CONNECTIVITY AND TEST EQUIPMENT	
	<p>Poli-MOD® Patch and Splice Module</p> <p>The Poli-MOD is an innovative patch and splice module which allows for increased densities in an incremental growth platform. Based on the LGX® 118 footprint, this product is capable of supporting up to 144 patch and splices in a standard 4U panel, resulting in 1296 patch and splices within a seven foot rack (38RU).</p>
	<p>Field-Installable Connectors</p> <p>FASTConnect®: Factory pre-polished, field-installable connectors that completely eliminate the need for hand polishing in the field.</p> <p>FUSEConnect®: With a factory pre-polished ferrule, its innovative field-termination process eliminates polishing, adhesives and crimping in the field, minimizing the potential for operator error and expensive connector scrap.</p>
	<p>Test, Inspection and Cleaning Equipment</p> <p>AFL's test, inspection and cleaning products consistently meet and exceed customer needs. AFL delivers exceptional fiber optic test equipment and outstanding service. Our ISO 9001:2008 certification and quality practices ensure you receive excellent products and documentation.</p>
	<p>Fusion Splicing Equipment</p> <p>AFL offers an extensive lineup of fusion splicers for field splicing applications. From the world's smallest fusion splicer to the world's first fully ruggedized splicer, Fujikura has been the pioneer in fusion splicing technology since 1979. Current generation field models offer unmatched speed, ruggedness and reliability.</p>
25-Year Warranty on End-to-End Fiber Optic Systems	
	<p>ACE Program 25-Year Warranty</p> <p>Standards-based, 25-year performance warranty written around performance standards to give your customers peace of mind for the 25-year design life of their fiber installation.</p>

eABF® Fiber Optic Cable

eABF® Solutions

Lifetime Warranty on End-to-End Fiber Optic Systems

As the first telecommunications company to offer a lifetime warranty* on end-to-end fiber optic systems including eABF systems, AFL partners with system integrators that possess the same quality of workmanship as we do. We carefully select partners that are as stringent about quality workmanship as we are at AFL. Plus, we are continually building our network of AFL Certified Expert (ACE) Installers that design and install AFL systems.

As an ACE Installer, you will be confident in designing and installing an AFL system that will fit the needs of your customers, as well as give them the peace of mind that a lifetime warranty offers. This, coupled with AFL's excellent technical support and the best products and solutions in the industry, will truly differentiate you from your competition.

AFL offers each ACE Installer extensive hands-on training that will help you understand the products we manufacture better, as well as develop your fiber optic knowledge and installation practices. After the training is complete, you will have all the necessary tools to design and install a completely warranted AFL system.

Learn more about the ACE program at www.afglobal.com/Resources/AFL-Certified-Expert-Installers-Program.aspx.



ACE Program Highlights

- Cutting-edge technology – develop a better understanding of fiber technology ensuring you remain ahead of your competition
- Single-source fiber supplier – one company to go to for all of your fiber and technical support needs
- Standards-based, 25-year performance warranty written around performance standards to give your customers peace of mind for the 25-year design life of their fiber installation
 - ANSI/TIA-568-C.0, *Generic Telecommunications Cabling for Customer Premises*
 - ANSI/TIA-568-C.3, *Optical Fiber Cabling Components Standard*
- Fiber training, design and support – become more proficient in designing, installing and testing a fiber system
- BICSI credits – AFL's ACE training programs are BICSI-certified and qualify for BICSI continuing education credits (CEC)
- Engineering support – an engineer on call to help you better understand any technical issues so you can find the solution that best fits your customers needs and applications
- Marketing incentives – gain access to the power behind the AFL brand, including links on our website promoting you as an ACE Installer
- Rebate program – Earn rebates based on AFL product purchases from an authorized distributor

*Lifetime is defined as the System Design Lifetime which is 25 years.

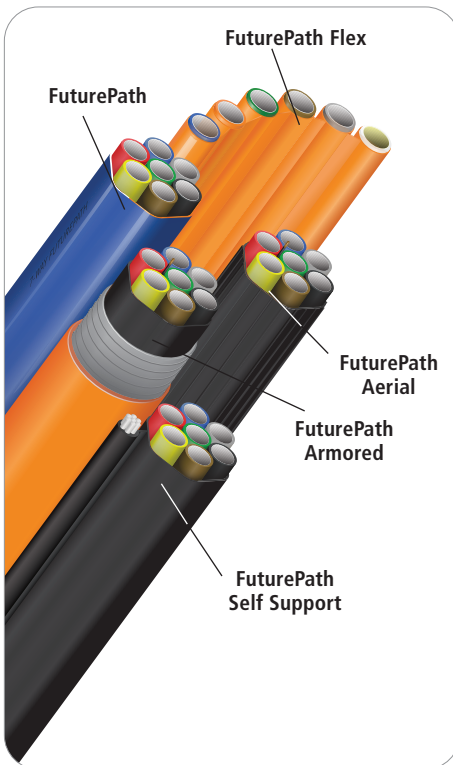

FuturePath Family of MicroDuct Products

Applications

- Campus settings
- Military
- Hospitals
- Industrial
- Government

Enterprise FuturePath Family

MicroTechnology is a forward-thinking, future-oriented technology that you can put in place today. As network infrastructure demands continue to grow, it becomes more important to better utilize the available space in your existing duct systems. Dura-Line MicroDucts and FuturePath allow for controlled growth of your network infrastructure, meeting bandwidth requirements as needed. With the multiple pathways in FuturePath, as your network grows, you will have available pathways without additional construction costs.

FuturePath is available in many sizes and configurations to suit your network installation needs. Manufacturing materials available are HDPE, riser, LSHF, plenum and armored. MicroDuct sizes include 12.7 mm and 8.5 mm to accommodate your fiber requirements. Configurations from single MicroDucts to 24 pathways will allow for rapid deployment of fiber today with permanent pathways in place for future growth.

A comprehensive line of Micro Accessories is available to complete your network. With our Enterprise End-to-End Solutions, Dura-Line offers micro couplers, cross-connect cabinets, splice closures, optical termination hardware and tools.

Versatile

With so many different styles, configurations and sizes of FuturePath available, there is virtually no fiber optic project that could not benefit from the use of FuturePath in both reducing initial construction costs and future proofing the network. FuturePath can be used in every facet of the network build, and by utilizing the different versions it can easily be installed in almost any scenario.

Expansion

With its many configurations, FuturePath can be utilized for expanding your network infrastructure, whether new or retrofit. MicroDuct(s) within FuturePath can be left open to accept a fiber optic cable in the future, for a cost effective way to add bandwidth. Crowded easements, both aerial and buried, can benefit from FuturePath for network expansion while requiring minimal space and disruption. When it comes to expanding your network, minimize expenditures and maximize capacity with FuturePath.

Features

- HDPE, riser, LSHF, plenum and armored options available
- 12.7 mm and 8.5 mm MicroDuct sizes
- Fiber counts up to 144
- Configurations include 24-way, 19-way, 12-way, 7-way, 4-way, 3-way or 2-way or single MicroDucts
- SILICORE® and SILICORE® ULF super slick permanent linings allow for higher speed cable jetting and longer cable installs
- Internal ribs—reduced friction for longer, faster cable installs
- Lightweight and flexible

continued
→

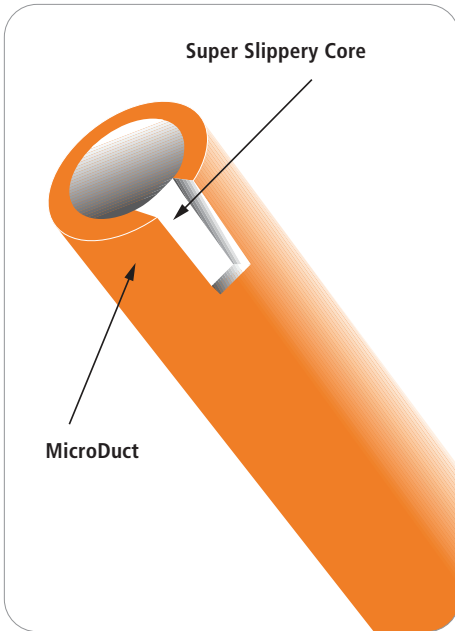

Enterprise FuturePath Family (cont.)

SILICORE® and SILICORE® ULF

SILICORE or SILICORE ULF are co-extruded on the inside of our tough, durable, FuturePath MicroDucts creating a super-slick permanent lining. SILICORE- and SILICORE ULF-lined ducts allow for higher speed cable jetting and longer cable pulls. The permanent pathway remains for future repairs, replacements or upgrades.

Features—SILICORE®

- Standard on Riser, Plenum and LSZH products
- Permanent—remains unchanged for life of MicroDuct
- Easier and faster cable installations
- Compatible with any cable jacket

Features—SILICORE® ULF

- Standard on all HDPE/OSP products
- Super slippery interior lining
- Permanent—remains unchanged for life of MicroDuct
- Easiest, fastest and farthest cable installs
- Lowest coefficient of friction
- Compatible with any cable jacket

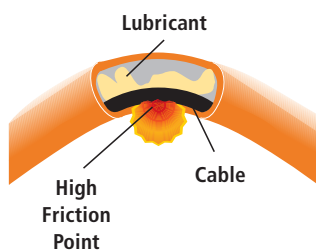
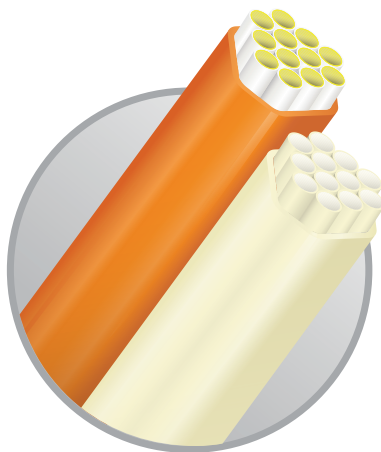

Heat builds and lubricant dissipates causing direct contact between cable and MicroDuct wall. Installation friction increases causing damage where the cable contacts the MicroDuct.

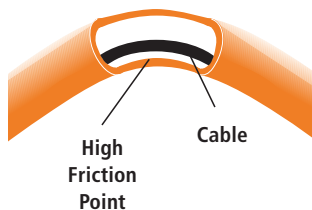

Cable remains in contact with SILICORE or SILICORE ULF. No burn-through. Low coefficient of friction. Easier and longer installations.

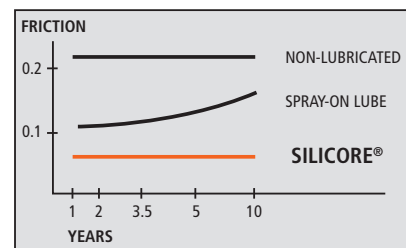

Low Coefficient of Friction

Enterprise FuturePath MicroDuct System

FuturePath is available in many sizes and configurations to suit your network installation needs. Manufacturing materials are HDPE, riser, LSHF, plenum and armored. MicroDuct sizes include 12.7 mm and 8.5 mm to accommodate your fiber requirements. Configurations from single MicroDucts to 24 pathways will allow for rapid deployment of fiber today with permanent pathways in place for future growth.

Configurations

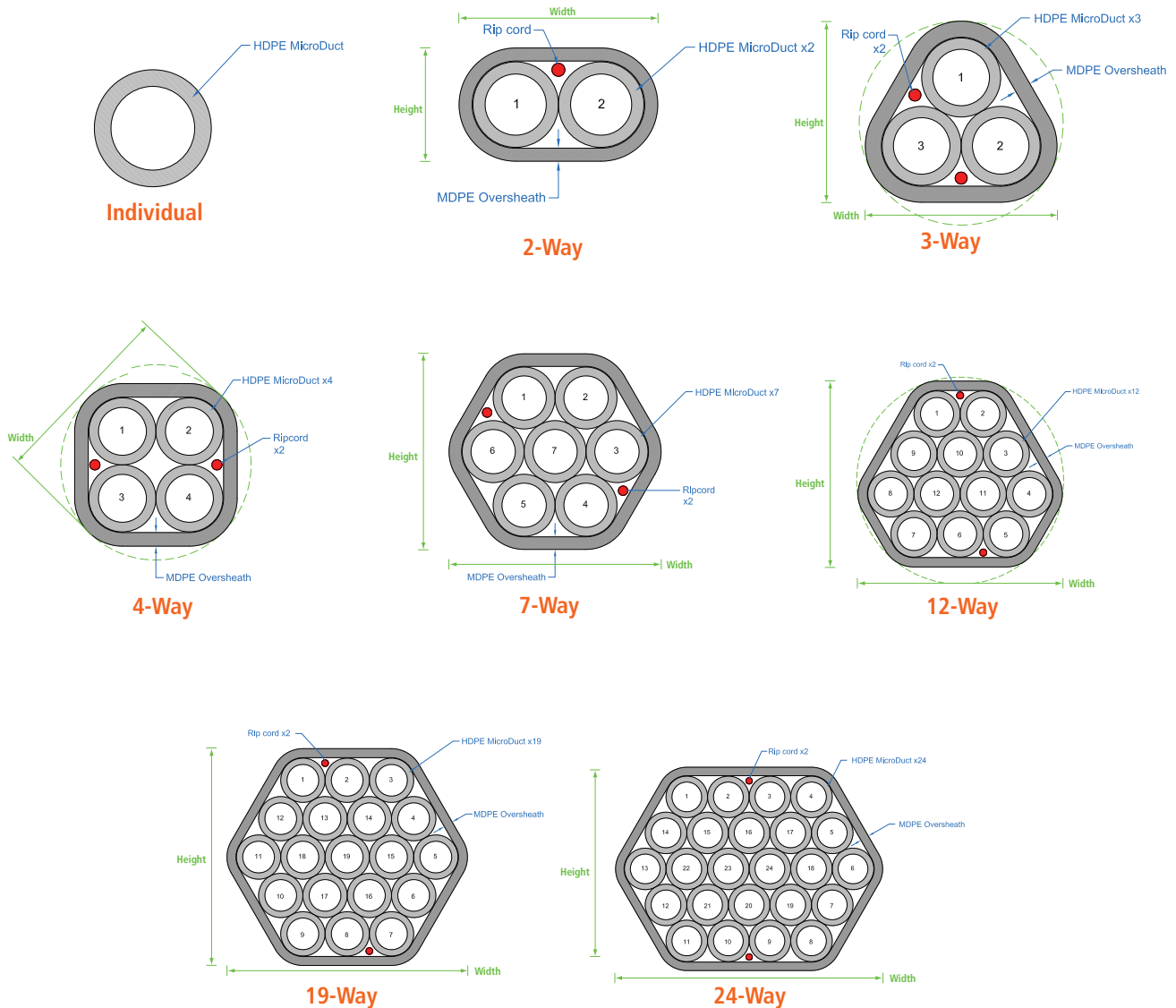

continued
→

Enterprise FuturePath MicroDuct System—12.7 mm/10 mm



FuturePath 7-Way Configuration

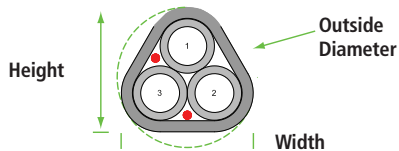

Outside Dimensions: Height x Width

Outside Diameter: Used to Calculate Fill Ratios

MicroDuct Specifications

PARAMETER	VALUE
OD	12.7 mm ± 0.10 (0.500" ± 0.004")
Wall Min.	1.30 mm (0.051")
Wall Max.	1.40 mm (0.055")
ID Min.	9.80 mm (0.386")
Materials	HDPE, Riser, Plenum, LSHF, Armored
Fiber Count	24, 36, 48, 72, 96, 144 strand MicroCable SM, MM
Shipping Length (in feet per reel)	1,000 2,500 5,000 6,000; Custom lengths available

FuturePath Mechanical Specifications

PARAMETER	CONFIGURATION			
	2-WAY	3-WAY	4-WAY	7-WAY
Outside Dimensions HxW (inches)	0.60/1.10	1.08/1.14	1.14/1.35	1.51/1.64
Outside Dimensions HxW (mm)	15.3/28.0	27.4/29.1	29.1/34.3	38.4/41.8
Outside Diameter (inches)	1.10	1.22	1.35	1.64
Outside Diameter (mm)	28.0	31.0	34.3	41.8
Over-Sheath Thickness	0.050"	0.070"	0.070"	0.070"
HDPE Over-Sheath Color	Orange	Orange	Orange	Orange
Rated Over-Sheath Color	Natural	Natural	Natural	Natural
MicroDuct Color	Natural	Natural	Natural	Natural
HDPE Locate Wire (optional)	20 ga.	20 ga.	20 ga.	20 ga.
Rated Locate Wire	No	No	No	No
RipCORDS	2	2	2	2
Bend Radius Supported	6"	11"	12"	15"
Bend Radius Un-Supported	12"	22"	24"	30"

Ordering Information

DESCRIPTION	DURA-LINE NO.				
	1000 FT	2500 FT	3250 FT	5000 FT	6000 FT
12.7 mm x 10 mm 1-way HDPE					
12.7 mm x 10 mm 2-way HDPE	10008852	10008853	—	10008854	—
12.7 mm x 10 mm 3-way HDPE	10008855	10008856	—	10008857	—
12.7 mm x 10 mm 4-way HDPE	10004748	10008858	—	10007545	—
12.7 mm x 10 mm 7-way HDPE	10004811	10008859	—	—	10004813
12.7 mm x 10 mm 1-way Riser	10008757	—	—	—	—
12.7 mm x 10 mm 2-way Riser	10004589	10008951	—	10008952	—
12.7 mm x 10 mm 3-way Riser	10004604	10008953	—	10008954	—
12.7 mm x 10 mm 4-way Riser	10004606	10008955	—	10008956	—
12.7 mm x 10 mm 7-way Riser	10004608	10004609	—	—	10004610
12.7 mm x 10 mm 1-way LSHF					
12.7 mm x 10 mm 2-way LSHF	10008889	10008890	—	10008891	—
12.7 mm x 10 mm 3-way LSHF	10008892	10008893	—	10008894	—
12.7 mm x 10 mm 4-way LSHF	10008895	10008896	—	10008897	—
12.7 mm x 10 mm 7-way LSHF	10008898	10008899	—	—	10008900
12.7 mm x 10.2 mm 1-way Plenum	10007408	—	—	—	—
12.7 mm x 10.2 mm 2-way Plenum	10008946	—	—	—	—
12.7 mm x 10.2 mm 3-way Plenum	10008947	—	—	—	—
12.7 mm x 10.2 mm 4-way Plenum	10008948	—	—	—	—
12.7 mm x 10.2 mm 7-way Plenum	10008949	—	—	—	—
12.7 mm x 10 mm 4-way Armored	—	—	—	10004891	—
12.7 mm x 10 mm 7-way Armored	—	—	10003729	—	—

continued
→

Enterprise FuturePath MicroDuct System—8.5 mm/6 mm



FuturePath 24-Way Configuration

MicroDuct Specifications

PARAMETER	VALUE
OD	8.5 mm ± 0.10 (0.335" ± 0.004")
Wall Min.	1.14mm (0.045")
Wall Max.	1.24mm (0.049")
ID Min.	5.92mm (0.233")
Materials	HDPE, Riser, Plenum, LSHF, Armored
Fiber Count	6, 12, 24, 48, 72, 96 strand MicroCable SM, MM
Shipping Length (in feet per reel)	1,000 2,500 4,000 5,000 6,000 Custom lengths available

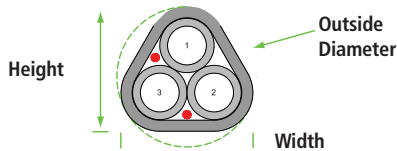

Outside Dimensions: Height x Width

Outside Diameter: Used to Calculate Fill Ratios

FuturePath Mechanical Specifications

PARAMETER	CONFIGURATION						
	2-WAY	3-WAY	4-WAY	7-WAY	12-WAY	19-WAY	24-WAY
Outside Dimensions HxW (inches)	0.44/0.77	0.75/0.79	0.79/0.93	1.04/1.13	1.33/1.46	1.62/1.80	1.62/2.13
Outside Dimensions HxW (mm)	11.2/19.7	19.0/20.2	20.2/23.7	26.4/28.7	33.8/37.2	41.1/45.7	41.1/54.2
Outside Diameter (inches)	0.77	0.85	0.93	1.13	1.48	1.80	2.13
Outside Diameter (mm)	19.7	21.5	23.7	28.7	37.7	45.7	54.2
Over-Sheath Thickness	0.050"	0.060"	0.060"	0.060"	0.060"	0.060"	0.060"
HDPE Over-Sheath Color	Orange	Orange	Orange	Orange	Orange	Orange	Orange
Rated Over-Sheath Color	Natural	Natural	Natural	Natural	Natural	Natural	Natural
MicroDuct	Natural	Natural	Natural	Natural	Natural	Natural	Natural
HDPE Locate Wire (optional)	20 ga.	20 ga.	20 ga.	20 ga.	20 ga.	20 ga.	20 ga.
Rated Locate Wire	No	No	No	No	No	No	No
RipCORDS	2	2	2	2	2	2	2
Bend Radius Supported	5"	8"	8"	11"	14"	16"	16"
Bend Radius Un-Supported	10"	16"	16"	22"	28"	32"	32"

continued
→

Enterprise FuturePath MicroDuct System—8.5 mm/6 mm (cont.)

Ordering Information

DESCRIPTION	DURA-LINE NO.				
	1000 FT	2500 FT	4000 FT	5000 FT	6000 FT
8.5 mm x 6 mm 1-way HDPE	10005861	—	—	—	—
8.5 mm x 6 mm 2-way HDPE	10004625	10008884	—	10004624	—
8.5 mm x 6 mm 3-way HDPE	10004654	10008885	—	10008886	—
8.5 mm x 6 mm 4-way HDPE	10004655	10004656	—	10008887	—
8.5 mm x 6 mm 7-way HDPE	10004659	10004874	—	—	10008888
8.5 mm x 6 mm 12-way HDPE	10004662	10004663	—	—	10004664
8.5 mm x 6 mm 19-way HDPE	10004665	10008882	—	—	10006770
8.5 mm x 6 mm 24-way HDPE	10004668	10008883	—	—	10004669
8.5 mm x 6 mm 1-way Riser	10008758	—	—	—	—
8.5 mm x 6 mm 2-way Riser	10004866	10004586	—	10008986	—
8.5 mm x 6 mm 3-way Riser	10008987	10008988	—	10008989	—
8.5 mm x 6 mm 4-way Riser	10004591	10004867	—	10008990	—
8.5 mm x 6 mm 7-way Riser	10004592	10008992	—	—	10004594
8.5 mm x 6 mm 12-way Riser	10004596	10008979	—	—	10008980
8.5 mm x 6 mm 19-way Riser	10004599	10008981	—	—	10008982
8.5 mm x 6 mm 24-way Riser	10004601	10008984	—	—	10008985
8.5 mm x 6 mm 1-way LSHF					
8.5 mm x 6 mm 2-way LSHF	10008934	10008935	—	10008936	—
8.5 mm x 6 mm 3-way LSHF	10008937	10008938	—	10008939	—
8.5 mm x 6 mm 4-way LSHF	10008940	10008941	—	10008942	—
8.5 mm x 6 mm 7-way LSHF	10008943	10008944	—	—	10008945
8.5 mm x 6 mm 12-way LSHF	10008925	10008926	—	—	10008927
8.5 mm x 6 mm 19-way LSHF	10008928	10008929	—	—	10008930
8.5 mm x 6 mm 24-way LSHF	10008931	10008932	—	—	10008933
8.5 mm x 6.7 mm 1-way Plenum	10008755	—	—	10008755	—
8.5 mm x 6.7 mm 2-way Plenum	10004851	10010091	—	10010093	—
8.5 mm x 6.7 mm 3-way Plenum	10008950	10010095	—	10010096	—
8.5 mm x 6.7 mm 4-way Plenum	10004853	10010092	—	10010094	—
8.5 mm x 6.7 mm 7-way Plenum	10004856	10010097	—	10010098	—
8.5 mm x 6.7 mm 12-way Plenum	10004857	10010099	—	10010100	—
8.5 mm x 6.7 mm 19-way Plenum	10004858	10010101	—	10010102	—
8.5 mm x 6.7 mm 24-way Plenum	10004859	10010103	—	10010104	—
8.5 mm x 6 mm 4-way Armored	—	—	10004888	—	—
8.5 mm x 6 mm 7-way Armored	—	—	10004889	—	—
8.5 mm x 6 mm 19-way Armored	—	—	10004890	—	—



MicroDuct Distribution Box

The MicroDuct Distribution Box or MDB is a convenient indoor junction box where multiple MicroDucts can be joined together. For example, this would be used to drop a tube to an adjacent floor, while allowing other MicroDucts to pass thru to the next MDB. The box is available in two basic sizes as noted below, and is a NEMA 12, continuous hinge wall mount type box. The box is used in conjunction with the ETA and DETA enclosure connectors.

Ordering Information

DURA-LINE NO.	CONFIGURATION	DESCRIPTION
20002884	16 x 14 x 8 NEMA 12	Box 16x14x8 NEMA 12 JIC 1 Door Continuous Hinge Wall Mount — MDB
20003021	20 x 20 x 7 NEMA 12	Box 20x20x7 NEMA 12 JIC 1 Door Continuous Hinge Wall Mount — MDB

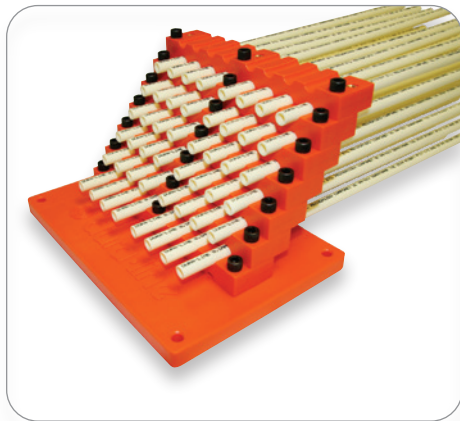

MicroDuct Organizer

The MicroDuct organizer is designed for neat and orderly termination of MicroDucts. It requires only a minimum amount of space to mount and is a modular system. For the first 1-8 MicroDucts, order one Mounting Plate (includes base bracket) and one Mounting Bracket. For additional expansion (9 or more MicroDucts), only the Mounting Brackets are required.

Ordering Information

DURA-LINE NO.	DESCRIPTION
20002120	8.5 mm MicroDuct Wall Mounting Plate (includes wall plate, base bracket and 3 screws; top mounting bracket not included)
20001719	8.5 mm MicroDuct Mounting Bracket with 3 screws (each bracket secures a row of 8 MicroDucts, with 3 screws)
20002121	12.7 mm MicroDuct Wall Mounting Plate (includes wall plate, base bracket and 3 screws; top mounting bracket not included)
20001929	12.7 mm MicroDuct Mounting Bracket with 3 screws (each bracket secures a row of 8 MicroDucts, with 3 screws)



MDS Enclosure

Wall-Mounted Distribution Enclosure specially designed for MicroDuct cable routing. Completely customizable to accept multiple cables or duct. The Micro Duct Distribution System (MDS) Enclosure is highly versatile to accommodate and optimize the distribution and termination of air-blown cable and duct as well as traditional fiber optic cable. The first of its kind, it optimizes the splicing and distribution of microduct systems in one enclosure, which eliminates extra parts and reduces the amount of room needed to distribute individual ducts.

Features

- MDS (Micro Duct Distribution System) designed for Data Center and indoor DAS applications
- The MDS can be used for managing all forms of duct up to 2.5" OD
- The MDS can be used as a breakout box for routing large count cables into an OCEF
- Scalable—the MDS can be deployed as a single unit or stacked and attached back to back for larger jobs
- The MDS can be used as a termination point as well as a pass through
- Unique angular design allows for gentle sweeps to enhance fiber blowing
- Can be mounted to the wall or overhead ladder rack
- When mounting the unit on ladder rack, it can be positioned to make optimal use of its ports
- The mounting brackets work on 12", 18", and 24" ladder rack
- The MDS can be mounted above or below the ladder rack
- Duct mounting options include the use of cord grips, hose clamps, or tie wraps
- The MDS will accept splice trays
- The rectangular front ports accept an industry standard LGX 118 adapter plate or cassette
- The closure features captive/non-captive openings
- Cabinet has a knock out feed through for when stacking
- MDS has front knock outs for single bulkhead adapters
- Can be housed in a NEMA 6P closure in a OSP environment
- Powder coated steel construction
- Mounting plates available for the 12.7/10 and 8.5/6 bulkheads and ducts up to 2.5" OD, and LGX 118 plates and cassettes.
- There are express ports on each side of the front rectangular slots for 12.7/10 and 8.5/6 bulkheads. Additional laterals can be added if the plates are full.



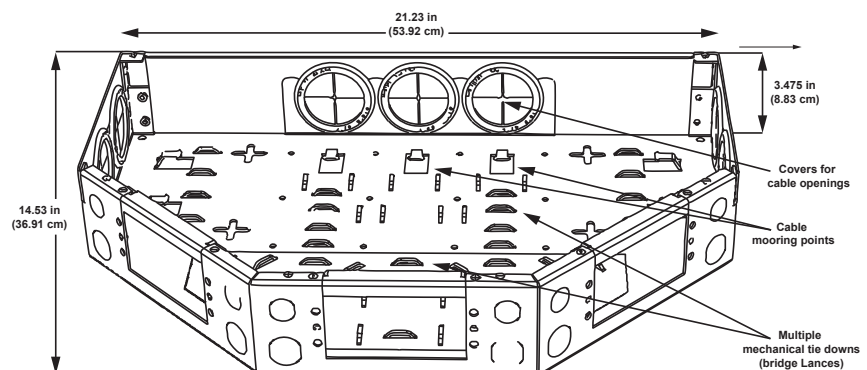



Dimensions









continued

MDS Enclosure

Ordering Information

DURA-LINE NO.	DESCRIPTION	PACKAGING	IMAGE
20003845	WALL MOUNT MULTI-CABLE DISTRIBUTION ENCLOSURE, BLACK Designed for MicroDuct cable routing. Customizable to accept multiple cables/ducts. Can provide splice/patch point for fiber optic cables as well as ducts. Has (6) 2.5" ports for cable/duct entry and (6) "L" Type Plate mounting slots. Includes (6) L-type blank plates, accessory bag.	EA	
20003846	MDS STAND-OFF BRACKETS FOR LADDER RACK MOUNT Set of (2) Brackets that are designed to mount enclosure either below or above existing ladder rack structure.	PAIR	
20003847	MDS BULKHEAD PLATE 2.5" CABLE OPENING AND STRAIN SUPPORT 2-SLOT Cover plate containing 2.5" cable openings. Accepts grommet and includes tie-down point. Can be used when current cable entry point are not satisfactory. Maximum of (3) plates per enclosure.	EA	
20003848	MDS BULKHEAD PLATE 8 POSITION 8.5 MM 2-SLOT Cover plate containing openings for (8) Dura-Line No. 20001712 8.5 mm bulkhead couplers for distributing 8.5 mm OD single tubes outside of enclosure. Maximum of (3) plates per enclosure.	EA	
20003849	MDS BULKHEAD PLATE L-TYPE 6 POSITION 8.5 MM 1 SLOT L-Type Plate, accepts (6) Dura-Line No. 20001712 8.5 mm Bulkhead Couplers for distributing 8.5 mm OD single tubes outside of enclosure. Maximum of (6) plates per enclosure.	EA	
20003850	MDS BULKHEAD PLATE L-TYPE 3 POSITION 12.7 MM 2 SLOT 2-Slot L-Type Bulkhead Plate, accepts (3) Dura-Line No. 20003017 12.7 mm Bulkhead Couplers for distributing 12.7 mm OD single tubes outside of enclosure.	EA	
20003851	BULKHEAD PLATE, L-TYPE, BLANK L-Type Blank Bulkhead Plate for covering unused slots in enclosure.	EA	

ACCESSORIES

20003852	Hose Clamp 0.5" - 1.25"	EA	
20003858	HOSE CLAMP 1.25" - 2.25"	EA	
20003853	CABLE TIE 15" 50 lb UV Black	EA	
20003854	MDS REPLACEMENT SCREW 10/32 x 1/4" Panhead Black	EA	
20003855	MDS LADDER BRACKET SCREW 10/32 x 5/16" Panhead Back	EA	
20003856	MDS WALL MOUNT SCREW, 1"	EA	
20003857	MDS 2.5 MM WEB GROMMET	EA	



Couplers, End Caps and Plugs



Bulkhead Fitting



Gas Block Connector



MicroDuct Round Cutter



MicroDuct Straight Cutter



Ratchet Cutter

Accessories

A comprehensive line of Micro Accessories are available to complete your network. With our Enterprise End-to-End Solutions, we offer Micro Couplers, Cross-Connect Cabinets, Splice Closures, Optical Termination Hardware and Tools.

Ordering Information—Accessories

PRODUCT TYPE	DESCRIPTION	DURA-LINE NO.
COUPLERS		
12.7 mm x 12.7 mm	Straight Coupler	20001832
8.5 mm x 8.5 mm	Straight Coupler	20001834
TRANSITIONS		
8.5 mm x 8 mm	Reducer Coupler	20001884
8.5 mm x 5 mm	Reducer Coupler	20001883
8 mm x 5 mm	Reducer Coupler	20003016
10 mm x 8.5 mm	Reducer Coupler	20001881
END CAPS		
12.7 mm	End Cap	20001482
8.5 mm	End Cap	20001819
PLUGS		
12.7 mm	End Plug	20002828
8.5 mm	End Plug (for HDPE and Riser Only)	20001523
BULKHEAD FITTINGS		
12.7 mm	12.7 mm Bulkhead Connector with Lock Ring	20003017
8.5 mm	8.5 mm Bulkhead Connector with Lock Ring	20001712
GAS BLOCK CONNECTORS		
8.5 mm	8.5/6 mm Gas Block Connector for cable 3.3-4.0 mm	20002104
12.7 mm	12.7/10 mm Gas Block Connector for cable 5 mm - 8 mm	20003363
TOOLS		
Cutter 8-19 mm	MicroDuct Straight Cutter 8-19 mm OD	20001856
Cutter Round	Round MicroDuct Cutter	20005284
Cutter Ratchet	2 in. Ratchet Cutter	20001803
Cutter Ratchet 1-1/2"	1-1/2" Ratchet Cutter	20001923
Slitter	Slitter Longitudinal	20001937
Slitter	Longitudinal Sheath Slitter	20003768
Unlocking Tool	Tool MicroDuct Coupler Collet Unlocking Tool	20001866
CLOSE-DOWN ASSEMBLY		
8.5 mm	8.5 mm Close-Down Assembly Kit	20004981



Longitudinal Sheath Slitter



Close-Down Assembly

continued
→

Accessories (cont.)

Ordering Information—Connectors

PRODUCT TYPE	DESCRIPTION	DURA-LINE NO.
FUTUREPATH ENCLOSURE CONNECTORS		
8.5/6 X 1	Enterprise - FuturePath Enclosure Connector D 8.5 mm x 1	20003048
8.5/6 X 2	Enterprise - FuturePath Enclosure Connector D 8.5 mm x 2	20001915
8.5/6 X 3	Enterprise - FuturePath Enclosure Connector D 8.5 mm x 3	20003049
8.5/6 X 4	Enterprise - FuturePath Enclosure Connector D 8.5 mm x 4	20001916
8.5/6 X 7	Enterprise - FuturePath Enclosure Connector D 8.5 mm x 7	20001917
8.5/6 X 12	Enterprise - FuturePath Enclosure Connector D 8.5 mm x 12	20001918
8.5/6 X 19	Enterprise - FuturePath Enclosure Connector D 8.5 mm x 19	20001919
8.5/6 X 24	Enterprise - FuturePath Enclosure Connector D 8.5 mm x 24	20001920
12.7/10 X 1	Enterprise - FuturePath Enclosure Connector D 12.7 mm x 1	20003050
12.7/10 X 2	Enterprise - FuturePath Enclosure Connector D 12.7 mm x 2	20003051
12.7/10 X 3	Enterprise - FuturePath Enclosure Connector D 12.7 mm x 3	20003052
12.7/10 X 4	Enterprise - FuturePath Enclosure Connector D 12.7 mm x 4	20003053
12.7/10 X 7	Enterprise - FuturePath Enclosure Connector D 12.7 mm x 7	20003054



FuturePath Enclosure Connector

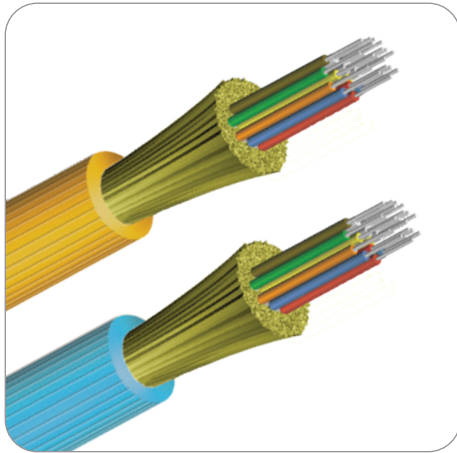

Enterprise Blown Fiber (eABF®) Cable

eABF cables are designed by AFL to offer the most rugged and reliable enterprise-based blown fiber solution in the market today. The patent pending cable design combines a light-weight, high-drag jacketing system that allows the cable to be blown long distances. The cable series also features additional attributes that set this product above and beyond traditional blown fiber cables. These enhanced features include mechanical strengthening that permits the cable to comply with industry-standard premise interconnect specifications. In addition, the eABF cable series feature flame-resistance characteristics which result in stand-alone riser and plenum rated options suitable for routing outside of the micro-duct system. Because of these mechanical, environmental and optical qualifications, eABF cables can also be installed in third-party, flame-rated duct and pathway systems.

Applications

- Designed for Data Center Interconnect
- Horizontal Distribution
- Backbone Distribution
- Low-cost fiber upgrade migration strategies

Features

- Contains water-blocking components for additional fiber protection from accidental water exposure
- Can be installed in eABF duct or third-party rated duct systems
- Complete range of single-mode and multimode fibers to support 10G, 40G and 100G Ethernet architectures
- Aramid-strengthened cable core for robust tensile load bearing capabilities
- OD compatible with 6 mm ID Micro-ducts for higher density fiber pathway solutions
- 96-Fiber count fits into 8.5 mm x 6 mm Micro-duct for up to 2,304 fibers per 24-way Dura-Line FuturePath Duct

Specifications—eABF Optical Fiber

FIBER TYPE	ISO DESIGNATION	MAXIMUM ATTENUATION (dB/km)				OVERFILL LAUNCH MIN. BANDWIDTH (MHz-km)		EMBC (MHz-km)	GIGABIT ETHERNET MAX. LINK DISTANCE (Meters)		10 GIGABIT ETHERNET MAX. LINK DISTANCE (Meters)	
		850 nm	1300 nm	1310 nm	1550 nm	850 nm	1300 nm		850 nm	1300 nm	850 nm	1300 nm
62.5/125	OM1	3.5	1.2	N/A	N/A	200	600	N/A	300	550	32	N/A
50/125	OM2 BIF	3.5	1.2	N/A	N/A	500	500	N/A	600	600	82	N/A
50/125	OM3 BIF	3.0	1.2	N/A	N/A	1500	500	2000	1000	550	300	N/A
50/125	OM4 BIF	3.0	1.2	N/A	N/A	3500	550	4700	1040	550	550	N/A
SM	OS2 (G.652D/G.657.A1)	N/A	N/A	0.4	0.4	N/A	N/A	N/A	N/A	N/A	N/A	N/A

BIF = Bend Insensitive Fiber

Estimated Installation Distances

OD/ID	DISTANCE (FT)
V-20 Install Distance—eABF 3.6 mm (6-24 Fibers)	
8.5 x 6	3,000
V-20 Install Distance—eABF 3.8 mm (48 Fibers)	
8.5 x 6	2,500
V-20 Install Distance—eABF 4.5 mm (72-96 Fibers)	
8.5 x 6	1,500

continued
→

Enterprise Blown Fiber (eABF) Cable (cont.)

Mechanical Data—Riser (OFNR)

DURA-LINE NO.	DESCRIPTION	PRODUCT TYPE	FIBER COUNT	NOMINAL DIAMETER	WEIGHT LBS/1,000 FT (KG/KM)	MAXIMUM TENSILE LOAD		MINIMUM BEND RADIUS	
				INCHES (MM)		SHORT TERM LBS (N)	LONG TERM LBS (N)	SHORT TERM INCHES (MM)	LONG TERM INCHES (MM)
20002960	MicroCable Riser ENT-A SM-6	SMF	6	0.14 (3.6)	6.4 (9.5)	22 (100)	7 (30)	1.2 (30)	0.8 (20)
20002866	MicroCable Riser ENT-A SM-12	SMF	12	0.14 (3.6)	6.7 (10.0)	22 (100)	7 (30)	1.2 (30)	0.8 (20)
20000729	MicroCable Riser ENT-A SM-24	SMF	24	0.14 (3.6)	7.4 (11.0)	22 (100)	7 (30)	1.2 (30)	0.8 (20)
20000730	MicroCable Riser ENT-A SM-48	SMF	48	0.15 (3.8)	9.4 (14.0)	22 (100)	7 (30)	1.2 (30)	0.8 (20)
20003201	MicroCable Riser ENT-A SM-72	SMF	72	0.18 (4.5)	14.0 (20.8)	22 (100)	7 (30)	3.6 (90)	1.8 (45)
NEW 20003628	MicroCable Riser SMF-72 200 µm	SMF 200 µm	72	0.15 (3.8)	11.0 (16.4)	22 (100)	7 (30)	1.2 (30)	0.8 (20)
20003630	MicroCable Riser ENT-A SM-96	SMF 200 µm	96	0.18 (4.5)	16.0 (23.8)	22 (100)	7 (30)	3.6 (90)	1.8 (45)
20002961	MicroCable Riser ENT-A OM1-6	OM1 (62.5/125)	6	0.14 (3.6)	6.4 (9.5)	22 (100)	7 (30)	1.2 (30)	0.8 (20)
20002848	MicroCable Riser ENT-A OM1-12	OM1 (62.5/125)	12	0.14 (3.6)	6.7 (10.0)	22 (100)	7 (30)	1.2 (30)	0.8 (20)
20002962	MicroCable Riser ENT-A OM1-24	OM1 (62.5/125)	24	0.14 (3.6)	7.4 (11.0)	22 (100)	7 (30)	1.2 (30)	0.8 (20)
20002963	MicroCable Riser ENT-A OM1-48	OM1 (62.5/125)	48	0.15 (3.8)	9.4 (14.0)	22 (100)	7 (30)	1.2 (30)	0.8 (20)
20003333	MicroCable Riser ENT-A OM1-72	OM1 (62.5/125)	72	0.18 (4.5)	14.0 (20.8)	22 (100)	7 (30)	3.6 (90)	1.8 (45)
20002964	MicroCable Riser ENT-A OM2-6	OM2 (50/125)	6	0.14 (3.6)	6.4 (9.5)	22 (100)	7 (30)	1.2 (30)	0.8 (20)
20002965	MicroCable Riser ENT-A OM2-12	OM2 (50/125)	12	0.14 (3.6)	6.7 (10.0)	22 (100)	7 (30)	1.2 (30)	0.8 (20)
20002966	MicroCable Riser ENT-A OM2-24	OM2 (50/125)	24	0.14 (3.6)	7.4 (11.0)	22 (100)	7 (30)	1.2 (30)	0.8 (20)
20002967	MicroCable Riser ENT-A OM2-48	OM2 (50/125)	48	0.15 (3.8)	9.4 (14.0)	22 (100)	7 (30)	1.2 (30)	0.8 (20)
20003334	MicroCable Riser ENT-A OM2-72	OM2 (50/125)	72	0.18 (4.5)	14.0 (20.8)	22 (100)	7 (30)	3.6 (90)	1.8 (45)
20002968	MicroCable Riser ENT-A OM3-6	OM3 (50/125)	6	0.14 (3.6)	6.4 (9.5)	22 (100)	7 (30)	1.2 (30)	0.8 (20)
20002969	MicroCable Riser ENT-A OM3-12	OM3 (50/125)	12	0.14 (3.6)	6.7 (10.0)	22 (100)	7 (30)	1.2 (30)	0.8 (20)
20000695	MicroCable Riser ENT-A OM3-24	OM3 (50/125)	24	0.14 (3.6)	7.4 (11.0)	22 (100)	7 (30)	1.2 (30)	0.8 (20)
20002883	MicroCable Riser ENT-A OM3-48	OM3 (50/125)	48	0.15 (3.8)	9.4 (14.0)	22 (100)	7 (30)	1.2 (30)	0.8 (20)
20003335	MicroCable Riser ENT-A OM3-72	OM3 (50/125)	72	0.18 (4.5)	14.0 (20.8)	22 (100)	7 (30)	3.6 (90)	1.8 (45)
20002970	MicroCable Riser ENT-A OM4-6	OM4 (50/125)	6	0.14 (3.6)	6.4 (9.5)	22 (100)	7 (30)	1.2 (30)	0.8 (20)
20002971	MicroCable Riser ENT-A OM4-12	OM4 (50/125)	12	0.14 (3.6)	6.7 (10.0)	22 (100)	7 (30)	1.2 (30)	0.8 (20)
20002972	MicroCable Riser ENT-A OM4-24	OM4 (50/125)	24	0.14 (3.6)	7.4 (11.0)	22 (100)	7 (30)	1.2 (30)	0.8 (20)
20000696	MicroCable Riser ENT-A OM4-48	OM4 (50/125)	48	0.15 (3.8)	9.4 (14.0)	22 (100)	7 (30)	1.2 (30)	0.8 (20)
20003272	MicroCable Riser ENT-A OM4-72	OM4 (50/125)	72	0.18 (4.5)	14.0 (20.8)	22 (100)	7 (30)	3.6 (90)	1.8 (45)

continued



Enterprise Blown Fiber (eABF) Cable (cont.)

Mechanical Data—Plenum (OFNP)

DURA-LINE NO.	DESCRIPTION	PRODUCT TYPE	FIBER COUNT	NOMINAL DIAMETER	WEIGHT	MAXIMUM TENSILE LOAD		MINIMUM BEND RADIUS	
				INCHES (MM)		LBS/1,000 FT (KG/KM)	SHORT TERM LBS (N)	LONG TERM LBS (N)	SHORT TERM INCHES (MM)
20002973	MicroCable Plenum ENT-A SM-6	SMF	6	0.14 (3.6)	6.4 (9.5)	22 (100)	7 (30)	1.2 (30)	0.8 (20)
20002974	MicroCable Plenum ENT-A SM-12	SMF	12	0.14 (3.6)	6.7 (10.0)	22 (100)	7 (30)	1.2 (30)	0.8 (20)
20002975	MicroCable Plenum ENT-A SM-24	SMF	24	0.14 (3.6)	7.4 (11.0)	22 (100)	7 (30)	1.2 (30)	0.8 (20)
20001451	MicroCable Plenum ENT-A SM-48	SMF	48	0.15 (3.8)	9.4 (14.0)	22 (100)	7 (30)	1.2 (30)	0.8 (20)
20003337	MicroCable Plenum ENT-A SM-72	SMF	72	0.18 (4.5)	15.0 (22.3)	22 (100)	7 (30)	3.6 (90)	1.8 (45)
NEW 20003629	MicroCable Plenum SMF-72 200 µm	SMF 200 µm	72	0.15 (3.8)	11.0 (16.4)	22 (100)	7 (30)	1.2 (30)	0.8 (20)
20003631	MicroCable Plenum ENT-A SM-96	SMF 200 µm	96	0.18 (4.5)	16.0 (23.8)	22 (100)	7 (30)	3.6 (90)	1.8 (45)
20002976	MicroCable Plenum ENT-A M1-6	OM1 (62.5/125)	6	0.14 (3.6)	6.4 (9.5)	22 (100)	7 (30)	1.2 (30)	0.8 (20)
20002977	MicroCable Plenum ENT-A OM1-12	OM1 (62.5/125)	12	0.14 (3.6)	6.7 (10.0)	22 (100)	7 (30)	1.2 (30)	0.8 (20)
20002978	MicroCable Plenum ENT-A OM1-24	OM1 (62.5/125)	24	0.14 (3.6)	7.4 (11.0)	22 (100)	7 (30)	1.2 (30)	0.8 (20)
20002979	MicroCable Plenum ENT-A OM1-48	OM1 (62.5/125)	48	0.15 (3.8)	9.4 (14.0)	22 (100)	7 (30)	1.2 (30)	0.8 (20)
20003338	MicroCable Plenum ENT-A OM1-72	OM1 (62.5/125)	72	0.18 (4.5)	15.0 (22.3)	22 (100)	7 (30)	3.6 (90)	1.8 (45)
20002980	MicroCable Plenum ENT-A OM2-6	OM2 (50/125)	6	0.14 (3.6)	6.4 (9.5)	22 (100)	7 (30)	1.2 (30)	0.8 (20)
20002981	MicroCable Plenum ENT-A OM2-12	OM2 (50/125)	12	0.14 (3.6)	6.7 (10.0)	22 (100)	7 (30)	1.2 (30)	0.8 (20)
20002982	MicroCable Plenum ENT-A OM2-24	OM2 (50/125)	24	0.14 (3.6)	7.4 (11.0)	22 (100)	7 (30)	1.2 (30)	0.8 (20)
20002983	MicroCable Plenum ENT-A OM2-48	OM2 (50/125)	48	0.15 (3.8)	9.4 (14.0)	22 (100)	7 (30)	1.2 (30)	0.8 (20)
20003339	MicroCable Plenum ENT-A OM2-72	OM2 (50/125)	72	0.18 (4.5)	15.0 (22.3)	22 (100)	7 (30)	3.6 (90)	1.8 (45)
20002984	MicroCable Plenum ENT-A OM3-6	OM3 (50/125)	6	0.14 (3.6)	6.4 (9.5)	22 (100)	7 (30)	1.2 (30)	0.8 (20)
20002985	MicroCable Plenum ENT-A OM3-12	OM3 (50/125)	12	0.14 (3.6)	6.7 (10.0)	22 (100)	7 (30)	1.2 (30)	0.8 (20)
20002986	MicroCable Plenum ENT-A OM3-24	OM3 (50/125)	24	0.14 (3.6)	7.4 (11.0)	22 (100)	7 (30)	1.2 (30)	0.8 (20)
20002987	MicroCable Plenum ENT-A OM3-48	OM3 (50/125)	48	0.15 (3.8)	9.4 (14.0)	22 (100)	7 (30)	1.2 (30)	0.8 (20)
20003340	MicroCable Plenum ENT-A OM3-72	OM3 (50/125)	72	0.18 (4.5)	15.0 (22.3)	22 (100)	7 (30)	3.6 (90)	1.8 (45)
20002988	MicroCable Plenum ENT-A OM4-6	OM4 (50/125)	6	0.14 (3.6)	6.4 (9.5)	22 (100)	7 (30)	1.2 (30)	0.8 (20)
20002989	MicroCable Plenum ENT-A OM4-12	OM4 (50/125)	12	0.14 (3.6)	6.7 (10.0)	22 (100)	7 (30)	1.2 (30)	0.8 (20)
20002990	MicroCable Plenum ENT-A OM4-24	OM4 (50/125)	24	0.14 (3.6)	7.4 (11.0)	22 (100)	7 (30)	1.2 (30)	0.8 (20)
20002919	MicroCable Plenum ENT-A OM4-48	OM4 (50/125)	48	0.15 (3.8)	9.4 (14.0)	22 (100)	7 (30)	1.2 (30)	0.8 (20)
20003341	MicroCable Plenum ENT-A OM4-72	OM4 (50/125)	72	0.18 (4.5)	15.0 (22.3)	22 (100)	7 (30)	3.6 (90)	1.8 (45)

Qualifications

GOVERNING BODY	STANDARD CODE	COMPONENT
Telcordia	GR-409-CORE	Fiber Optic Cable
RoHS	2015/863	Fiber Optic Cable
UL	1666 (OFNR)	Riser Cables
NEC	2005 Art 770.51 (B)	Riser Cables
NFPA	262 OFNP	Plenum Cables

Temperature Specifications

TEMPERATURE RANGE	
INSTALLATION	0°C to +70°C
OPERATING*	0°C to +70°C
STORAGE	-40°C to +75°C

*Not intended for outside plant access during operational use.

Contact AFL for packaging details or any further questions.



eABF® SWR® Enterprise Air-Jetted Fiber Cable

The AFL eABF SWR (SpiderWeb Ribbon®) is a new innovation that combines the best of ribbon fiber mass-fusion functionality and single fiber-bundle packing density to enterprise fiber optic structured cabling materials. The SWR fiber bundle used in this version of the eABF air-jetted fiber optic cable allows for the design of round, high-fiber density geometry yet offers the installer the ability to quickly and efficiently install MPO multi-fiber connectors or mass-fusion splicing without having to sort out and arrange individual fibers. In addition, because of SWR fiber binding system, the individual optical fibers can be easily separated and terminated as single fiber units.

The eABF SWR cable meets the interconnect standards of Telcordia GR-409 and is rated to meet NFPA/NEC flame-safety requirements as a stand-alone cable yet can be jetted thousands of feet in the Dura-Line FuturePath MicroDuct pathway system.

Features

- 24, 48, 72 and 144 fiber options increase design flexibility without increasing space or installation time (labor costs) requirements
- Riser and Plenum options for use in riser or plenum pathway environments (outside of micro-duct)
- Contains water-blocking components for additional fiber protection from accidental water exposure
- Innovative fiber-ribbon bonding allows for higher density cable than traditional flat, fiber-ribbon
- SpiderWeb Ribbon technology reduces cable diameter to improve pathway space and cooling channel efficiencies
- Cable can be routed within cable management pathways (outside of micro-duct)
- OM3, OM4 and single-mode optical fiber options which support easy migration to IEEE 802.3ba 40GbE and 100GbE applications
- Optimized for high-density terminations for excellent integration with MPO-based and mass-fusion spliced connectivity solutions
- Environment-safe materials reduces concern for handling of cables
- Cables can be de-installed and reused to meet LEED-design guidelines for green building initiatives

SWR Technology

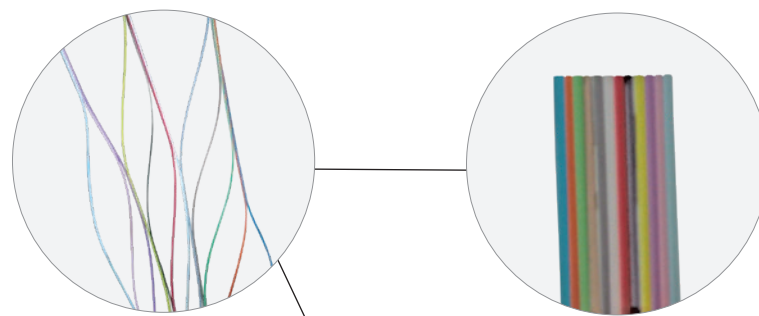

Cable Components

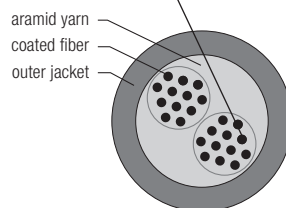

24 Fiber eABF SWR

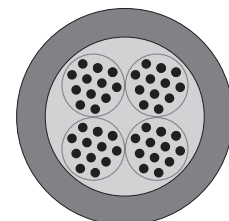

48 Fiber eABF SWR

continued
→



eABF® SWR® Enterprise Air-Jetted Fiber Cable

Ordering Information and Mechanical Data

DURA-LINE NO.	DESCRIPTION	FIBER TYPE	FIBER COUNT	NOMINAL DIAMETER		WEIGHT	MAX. TENSILE LOAD LBS (N)		MIN. BEND RADIUS INCHES (MM)	
				INCHES (MM)	LBS/KFT (KG/KM)		SHORT TERM	LONG TERM	SHORT TERM	LONG TERM
PLENUM										
20003524	MicroCable SWR Plenum ENT-A SMF-SWR-12	SMF-SWR	12	0.14 (3.5)	7.4 (11.0)	22 (100)	7 (30)	2.0 (56)	1.5 (35)	
20003525	MicroCable SWR Plenum ENT-A OM3-SWR-12	OM3-SWR	12	0.14 (3.5)	7.4 (11.0)	22 (100)	7 (30)	2.0 (56)	1.5 (35)	
20003526	MicroCable SWR Plenum ENT-A OM4-SWR-12	OM4-SWR	12	0.14 (3.5)	7.4 (11.0)	22 (100)	7 (30)	2.0 (56)	1.5 (35)	
20003374	MicroCable SWR Plenum ENT-A SMF-SWR-24	SMF-SWR	24	0.14 (3.5)	8.7 (12.9)	22 (100)	7 (30)	2.0 (56)	1.5 (35)	
20003375	MicroCable SWR Plenum ENT-A OM3-SWR-24	OM3-SWR	24	0.14 (3.5)	8.7 (12.9)	22 (100)	7 (30)	2.0 (56)	1.5 (35)	
20003376	MicroCable SWR Plenum ENT-A OM4-SWR-24	OM4-SWR	24	0.14 (3.5)	8.7 (12.9)	22 (100)	7 (30)	2.0 (56)	1.5 (35)	
20003306	MicroCable SWR Plenum ENT-A SMF-SWR-48	SMF-SWR	48	0.16 (4.0)	12 (17.9)	22 (100)	7 (30)	2.5 (60)	1.5 (35)	
20003307	MicroCable SWR Plenum ENT-A OM3-SWR-48	OM3-SWR	48	0.16 (4.0)	12 (17.9)	22 (100)	7 (30)	2.5 (60)	1.5 (35)	
20003308	MicroCable SWR Plenum ENT-A OM4-SWR-48	OM4-SWR	48	0.16 (4.0)	12 (17.9)	22 (100)	7 (30)	2.5 (60)	1.5 (35)	
NEW	20005465	MicroCable Plenum ENT-SWR SM-144 200 μm	SMF-SWR 200 μm	144	0.28 (7.2)	42 (62.5)	22 (100)	7 (30)	7 (160)	4 (80)
RISER										
20003521	MicroCable SWR Riser ENT-A SMF-SWR-12	SMF-SWR	12	0.14 (3.5)	7.4 (11.0)	22 (100)	7 (30)	2.0 (56)	1.5 (35)	
20003522	MicroCable SWR Riser ENT-A OM3-SWR-12	OM3-SWR	12	0.14 (3.5)	7.4 (11.0)	22 (100)	7 (30)	2.0 (56)	1.5 (35)	
20003523	MicroCable SWR Riser ENT-A OM4-SWR-12	OM4-SWR	12	0.14 (3.5)	7.4 (11.0)	22 (100)	7 (30)	2.0 (56)	1.5 (35)	
20003425	MicroCable Riser ENT-SWR SM-24	SMF-SWR	24	0.14 (3.5)	8.7 (12.9)	22 (100)	7 (30)	2.0 (56)	1.5 (35)	
20003424	MicroCable Riser ENT-SWR OM3-24	OM3-SWR	24	0.14 (3.5)	8.7 (12.9)	22 (100)	7 (30)	2.0 (56)	1.5 (35)	
20003428	MicroCable Riser ENT-SWR OM4-24	OM4-SWR	24	0.14 (3.5)	8.7 (12.9)	22 (100)	7 (30)	2.0 (56)	1.5 (35)	
20003303	MicroCable Riser ENT-SWR SM-48	SMF-SWR	48	0.16 (4.0)	11 (16.4)	22 (100)	7 (30)	2.5 (60)	1.5 (35)	
20003304	MicroCable Riser ENT-SWR OM3-48	OM3-SWR	48	0.16 (4.0)	11 (16.4)	22 (100)	7 (30)	2.5 (60)	1.5 (35)	
20003305	MicroCable Riser ENT-SWR OM4-48	OM4-SWR	48	0.16 (4.0)	11 (16.4)	22 (100)	7 (30)	2.5 (60)	1.5 (35)	
20003446	MicroCable SWR Riser ENT-A OM3-SWR-72	OM3-SWR	72	0.18 (4.5)	16 (23.8)	22 (100)	7 (30)	2.7 (67)	1.8 (45)	
20003447	MicroCable SWR Riser ENT-A OM4-SWR-72	OM4-SWR	72	0.18 (4.5)	16 (23.8)	22 (100)	7 (30)	2.7 (67)	1.8 (45)	
20003448	MicroCable SWR Riser ENT-4 SMF-SWR-72	SMF-SWR	72	0.18 (4.5)	16 (23.8)	22 (100)	7 (30)	2.7 (67)	1.8 (45)	
20003882	MicroCable Riser ENT-SWR SM-144	SMF-SWR	144	0.28 (7.2)	30 (44.6)	22 (100)	7 (30)	7 (160)	4 (80)	

Optical Specifications

FIBER TYPE	MAXIMUM ATTENUATION (dB/km)				OVERFILL LAUNCH MIN. BANDWIDTH (MHz•km)		EMB _c (MHz•km)	GIGABIT ETHERNET MIN. LINK DISTANCE (Meters)		10 GIGABIT ETHERNET MIN. LINK DISTANCE (Meters)	
	850 nm	1300 nm	1310 nm	1550 nm	850 nm	1300 nm		850 nm	1300 nm	850 nm	1300 nm
OM3	3.0	1.2	N/A	N/A	1500	500	2000	1000	550	300	N/A
OM4	3.0	1.2	N/A	N/A	3500	550	4700	1040	550	550	N/A
OS2	N/A	N/A	0.5	0.5	N/A	N/A	N/A	N/A	N/A	N/A	N/A

Qualifications

GOVERNING BODY	STANDARD CODE	COMPONENT
Telcordia	GR-409-CORE	Fiber Optic Cable
RoHS	2015/863	Fiber Optic Cable
UL	1666 (ONFR)	Riser Cables
NEC	2005 Art 770.51 (B)	Riser Cables
NFPA	262 OFNP	Plenum Cables

Temperature Specifications

TEMPERATURE RANGE	
INSTALLATION	0°C to +70°C
OPERATING	0°C to +70°C
STORAGE	-40°C to +75°C

*Not intended for outside plant access during operational use.

Contact AFL for further details.

AFLglobal.com | 800.235.3423

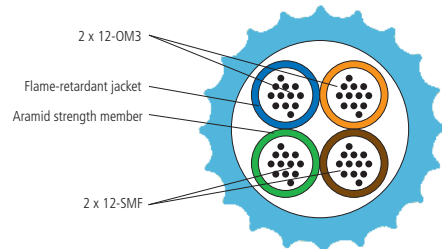
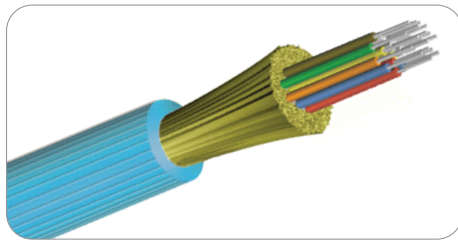

Example with OM3 and single-mode fibers

Hybrid Enterprise Blown Fiber (eABF®) Cable with Various Fiber Combinations

eABF cables are designed by AFL to offer the most rugged and reliable enterprise-based blown fiber solution in the market today. The patent pending cable design combines a light-weight, high-drag jacketing system that allows the cable to be blown long distances. The cable series also features additional attributes that set this product above and beyond traditional blown fiber cables. These enhanced features include mechanical strengthening that permits the cable to comply with industry-standard premise interconnect specifications. In addition, the eABF cable series feature flame-resistance characteristics which result in stand-alone riser rated options suitable for routing outside of the micro-duct system. Because of these mechanical, environmental and optical qualifications, eABF cables can also be installed in third-party flame-rated duct and pathway systems.

Features

- Flame-resistant cable jacket makes it suitable for routing outside of the micro-duct system
- Complete range of single-mode and multimode fibers to support 10G, 40G and 100G Ethernet architectures
- Aramid-strengthened cable core for robust tensile load bearing capabilities
- OD compatible with 6 mm ID Micro-ducts for higher density fiber pathway solutions
- Contains water-blocking components for additional fiber protection from accidental water exposure

Applications

- Designed for Data Center Interconnect
- Horizontal Distribution
- Vertical Distribution
- Inter and Intra-building optical circuits
- Low-cost fiber upgrade migration strategies

Specifications – eABF Optical Fiber

FIBER TYPE	ISO DESIGNATION	MAXIMUM ATTENUATION (DB/KM)			OVERFILL LAUNCH MIN. BANDWIDTH (MHZ-KM)		EMBC (MHZ-KM)	GIGABIT ETHERNET MIN. LINK DISTANCE (METERS)		10 GIGABIT ETHERNET MIN. LINK DISTANCE (METERS)	
		850 NM	1300 NM	1550 NM	850 NM	1300 NM		850 NM	1300 NM	850 NM	1300 NM
50/125	OM3	3.5	1.2	N/A	1500	500	2000	1000	550	300	N/A
SM	OS2	N/A	0.4	0.4	N/A	N/A	N/A	N/A	5000	N/A	10000

Estimated Installation Distances

OD/ID	AIR (FT/90°S)
8.5 x 6 , V-20 Install Distance—eABF 3.8 mm (6-24 Fibers)	2,300 / 24
8.5 x 6 , V-20 Install Distance—eABF 3.8 mm (48 Fibers)	2000 / 19

Standard eABF Cable Packaging

PACKAGE TYPE	STD P-U (FT)	PACKAGE WEIGHT	
		WEIGHT REEL	REEL + FULL LENGTH P-U
30 x 15 x 12	15,000	34 (15.5)	208 (311)
Reel-in-Box	1,000	10 (4.5)	23 (34)

Ordering Information

Many additional Hybrid variations and combinations of eABF cable available. Contact AFL or Dura-Line for additional configurations.

Qualifications

GOVERNING BODY	STANDARD CODE	COMPONENT
Telcordia	GR-409-CORE	Fiber Optic Cable
RoHS	2015/863	Fiber Optic Cable
UL	1666 (OFNR)	Riser Cables
NEC	2005 Art 770.51 (B)	Riser Cables
NFPA	262 OFNP	Plenum Cables

Temperature Specifications

TEMPERATURE RANGE	
INSTALLATION	0°C to +70°C
OPERATING*	0°C to +70°C
STORAGE	-40°C to +75°C

*Not intended for outside plant access during operational use.

Contact AFL for further details.





LM-Series OSP MicroCore® Cable

AFL OSP MicroCore® cable series (LM-Series) is designed for outside plant installation in microduct conduit systems. The foundation of the design is the multi-fiber-set, gel-filled buffer tube construction. The kink-resistant buffer tube contains multiple 12-fiber sets of color-coded fibers. Each set within the buffer tube is grouped using dual color-coded binder threads. The dry-blocked core is made up of SZ-stranded buffer tubes around a central strength member. The low-friction, high-strength overall jacketing system protects the cable-core while providing an optimized cable package supporting high-speed, long-distance jetting performance. The unique, high-fiber density geometry yields a cable construction that can accommodate up to 432 fibers and can be blown into microducts ranging in inside diameters from 10 mm to 16 mm.

Features

- 12 up to 432 250 µm fibers
- Low-friction outer jacket designed for air-blown installations
- Robust, kink-resistant buffer tubes reduce time and handling issues associated with enclosure build-outs
- 300lb installation tensile load rating
- OD compatible with 10 mm to 16 mm inside diameter microducts

Applications

- Long-haul, middle-mile and metro-loop
- Campus inter-building backbone distribution
- Low-cost fiber upgrade migration strategies

Cable Components

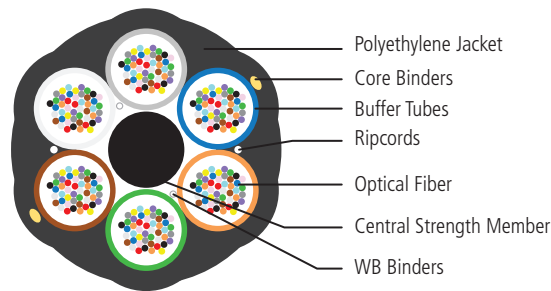

continued
→

LM-Series OSP MicroCore® Cable

Physical and Mechanical Data

LM-SERIES AFL NO.*	FIBER COUNT	FIBERS/ NUMBER OF TUBES**	DIAMETER		WEIGHT	MAXIMUM TENSILE LOAD		MINIMUM BEND RADIUS	
			INCHES (MM)	INCHES (MM)		LBS (N)		INCHES (CM)	
						INSTALLATION	OPERATION	INSTALLATION	OPERATION
LM012xC6101NS	12	12/1 (5 fillers)	0.31 (7.9)	0.39 (10.0)	31 (46)	300 (1334)	90 (400)	6.5 (16)	5 (12)
LM024xC6101NS	24	12/2 (4 fillers)	0.31 (7.9)	0.39 (10.0)	32 (48)	300 (1334)	90 (400)	6.5 (16)	5 (12)
LM048xC6101NS	48	12/4 (2 fillers)	0.31 (7.9)	0.39 (10.0)	33 (49)	300 (1334)	90 (400)	6.5 (16)	5 (12)
LM072xC6101NS	72	12/6	0.31 (7.9)	0.39 (10.0)	34 (51)	300 (1334)	90 (400)	6.5 (16)	5 (12)
LM096xO6101NS	96	24/4 (2 fillers)	0.31 (7.9)	0.39 (10.0)	34 (51)	300 (1334)	90 (400)	6.5 (16)	5 (12)
LM144xO6101NS	144	24/6	0.31 (7.9)	0.39 (10.0)	36 (53)	300 (1334)	90 (400)	6.5 (16)	5 (12)
LM288xR6101NS	288	48/6	0.41 (10.4)	0.51 (13.0)	63 (93)	300 (1334)	90 (400)	8.5 (21)	6.5 (16)
LM432xOI301NS	432	24/18	0.50 (12.6)	0.63 (16.0)	87 (130)	300 (1334)	90 (400)	10 (26)	7.5 (19)

* Replace "x" in AFL number with Fiber Identifier in the Fiber Specifications table below.

** Fibers are arranged in 12-fiber sets identified by colored binder threads. For fiber identification details [click here](#).

Optical Fiber Options

FIBER TYPE	"X"	STANDARD	MODE FIELD DIAMETER	ATTENUATION	
				1300 nm	1550 nm
250 µm Single-mode	9	ITU-T G.652D / 657.A1	9.2 µm nominal	0.35	0.25
Corning 250 µm Single-mode	AZ	ITU-T G.652D / 657.A1	9.2 µm nominal	0.35	0.25

Standard Packaging Details

FIBER COUNT	REEL DIMENSIONS (FLANGE X WIDTH)	STANDARD REEL LENGTH	TYPICAL TOTAL WEIGHT
12-144	48 x 36 in.	20,000 ft (6,096 m)	950 lbs (430 kg)
288	58 x 38 in.	20,000 ft (6,096 m)	1,800 lbs (816 kg)
432	66 x 42 in.	20,000 ft (6,096 m)	2,450 lbs (1,111 kg)

Recommended Products

DESCRIPTION	AFL NO.
Apex® X-2 Sealed Splice Closure	Refer to spec sheet for AFL No.
Apex® X-2S Sealed Splice Closure	Refer to spec sheet for AFL No.
FUSEConnect® MPO Splice-on Connectors	Refer to spec sheet for AFL No.
FUSEConnect® Field-installable Splice-on Connectors	Refer to spec sheet for AFL No.
LMHD-Series OSP MicroCore® Cable	Refer to spec sheet for AFL No.
Poli-MOD® Patch and Splice Module	Refer to spec sheet for AFL No.

Temperature Specifications

TEMPERATURE RANGE	
OPERATION	-30°C to +70°C
STORAGE	-30°C to +70°C
INSTALLATION	-10°C to +60°C

Qualifications

GOVERNING BODY	STANDARD CODE	COMPONENT
ANSI/ICEA	S-122-744	Cable
TIA	598-D	Fiber

Contact AFL for further details.



LM200-Series OSP MicroCore® Cable

The product design integrates 200 µm buffered single-mode fiber which allows for reduced diameter cables compared to traditional OSP micro-cables. The foundation of the design is the multi-fiber-set, gel-filled buffer tube construction. The kink-resistant buffer tube contains multiple 12-fiber sets of color-coded fibers. Each set within the buffer tube is grouped using dual color-coded binder threads. The dry-blocked core is made up of six buffer tubes SZ-stranded around a central strength member. The low-friction, high-strength overall jacketing system protects the cable-core while providing an optimized cable package supporting high-speed, long-distance jetting performance. The LM200-Series is the right choice for use in bundled micro-duct pathways allowing for future, incremental cable additions as network circuits and bandwidth requirements increase.

Features

- 24 to 432 fibers
- Robust, kink-resistant buffer tubes reduce time and handling issues associated with enclosure build-outs
- Low-friction jacketing system allows for longer jetting distances
- Designed for use in bundled micro-duct pathways allowing for future, optical circuit additions

Applications

- Long-haul, Local Loop FTTx, Campus Backbone connections for 10G, 40G, and 100G network transmission speeds
- Air-jetted into bundled micro-ducts
- Congested pathway over-ride installations

Cable Components

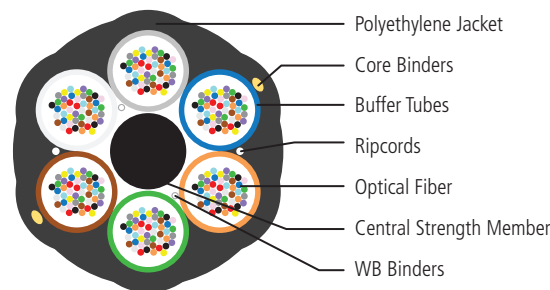

continued
→

LM200-Series OSP MicroCore® Cable

Physical and Mechanical Data

LM200-SERIES AFL NO.*	FIBER COUNT	FIBERS/ NUMBER OF TUBES**	DIAMETER		WEIGHT	MAXIMUM TENSILE LOAD		MINIMUM BEND RADIUS	
			INCHES (MM)	INCHES (MM)		LBS (N)	INCHES (CM)	INSTALLATION	OPERATION
LM024xO6101NS	24	24/1 (5 fillers)	0.248 (6.3)	0.315 (8)	21 (31)	200 (890)	60 (267)	5 (13)	4 (10)
LM048xO6101NS	48	24/2 (4 fillers)	0.248 (6.3)	0.315 (8)	22 (33)	200 (890)	60 (267)	5 (13)	4 (10)
LM072xO6101NS	72	24/3 (3 fillers)	0.248 (6.3)	0.315 (8)	23 (34)	200 (890)	60 (267)	5 (13)	4 (10)
LM096xO6101NS	96	24/4 (2 fillers)	0.248 (6.3)	0.315 (8)	24 (36)	200 (890)	60 (267)	5 (13)	4 (10)
LM144xO6101NS	144	24/6	0.248 (6.3)	0.315 (8)	26 (39)	200 (890)	60 (267)	5 (13)	4 (10)
LM288xR6101NS	288	48/6	0.319 (8.1)	0.394 (10)	43 (65)	300 (1334)	90 (400)	6.5 (17)	5 (13)
LM432xT6101NS	432	72/6	0.409 (10.4)	0.512 (13)	70 (104)	300 (1334)	90 (400)	8.5 (21)	6.5 (16)

* "x" denotes fiber type. See optical fiber specification table to complete AFL part number.

** Fibers are arranged in 12-fiber sets identified by colored binder threads. For fiber identification details [click here](#).

Optical Fiber Specifications

FIBER TYPE	"X"	STANDARD	MODE FIELD DIAMETER	ATTENUATION	
				1300 nm	1550 nm
200 µm Single-mode	BC	ITU-T G.652.D / 657.A1	9.2 µm nominal	0.35	0.25
Corning 200 µm Single-mode	BA	ITU-T G.652.D / 657.A1	9.2 µm nominal	0.35	0.25

Standard Packaging Details

FIBER COUNT	REEL DIMENSIONS (Flange x Width)	STANDARD REEL LENGTH	REEL WEIGHT	TYPICAL TOTAL WEIGHT
24-288	48 x 36 in.	19,000 ft (5,791 m)	140 lbs (64 kg)	1,100 lbs (500 kg)
432	58 x 38 in.	19,000 ft (5,791 m)	435 lbs (197 kg)	1,900 lbs (862 kg)

Recommended Products

DESCRIPTION	AFL NO.
Apex® X-2 Sealed Splice Closure	Refer to spec sheet for AFL No.
Apex® X-2S Sealed Splice Closure	Refer to spec sheet for AFL No.
Poli-MOD® Patch and Splice Module	Refer to spec sheet for AFL No.
FUSEConnect® MPO Splice-on Connectors	Refer to spec sheet for AFL No.
FUSEConnect® Field-installable Splice-on Connectors	Refer to spec sheet for AFL No.

Temperature Specifications







TEMPERATURE RANGE	
OPERATION	-30°C to +70°C
STORAGE	-30°C to +70°C
INSTALLATION	-10°C to +60°C

Qualifications

GOVERNING BODY	STANDARD CODE	COMPONENT
ANSI/ICEA	S-122-744	Cable
TIA	598-D	Fiber

Contact AFL for further details.

Connector Specifications

PARAMETER	CONNECTOR														
	SC		FC		ST		LC		MTP		MT-RJ		MU		
Single-mode Assemblies															
Image															
	Ultra	Angle	Ultra	Angle	Ultra	Angle	Ultra	Angle	Flat	Angle	Ultra	Angle	Ultra	Angle	
Insertion loss (dB)	Maximum	0.3	0.3	0.3	0.3	0.3	—	0.3	0.3	—	0.75	0.5	—	0.3	—
	Typical	0.15	0.2	0.25	0.2	0.15	—	0.15	0.15	—	0.35	0.25	—	0.2	—
Return Loss (dB)	Minimum	-55 dB	-65 dB	-55 dB	-65 dB	-55 dB	—	-55 dB	-65 dB	—	-55 dB	-35 dB	—	-55 dB	—
	Temp Range (°C)	-40 to +85		-40 to +85		-40 to +85		-40 to +85		-40 to +75		-40 to +75		-40 to +85	
Durability Cycles	500		500		500		500		200		200		500		

Multimode Assemblies															
Insertion loss (dB)	Maximum	0.5	—	0.5	—	0.5	—	0.3	—	0.75	—	0.5	—	0.5	—
	Typical	0.25	—	0.25	—	0.25	—	0.25	—	0.35	—	0.25	—	0.25	—
Return Loss (dB)	Minimum	-30 dB	—	-30 dB	—	-30 dB	—	-30 dB	—	-20 dB	—	-20 dB	—	-30 dB	—
	Temp Range (°C)	-40 to +85		-40 to +85		-40 to +85		-40 to +85		-40 to +75		-40 to +75		-40 to +85	
Durability Cycles	500		500		500		500		200		200		500		
Cable Options	Simplex/Duplex	Simplex/Duplex		Simplex/Duplex		Simplex/Duplex		Simplex/Duplex		Bare Ribbon		Bare Ribbon		900 µm	
	900 µm	900 µm		900 µm		900 µm		900 µm		Jacketed Ribbon		Jacketed Ribbon		2.0 mm	
Applications	1.6 mm	1.6 mm		1.6 mm		1.6 mm		1.6 mm		Jacketed Ribbon		Jacketed Ribbon		2.0 mm	
	2.0 mm	2.0 mm		2.0 mm		2.0 mm		2.0 mm		Dual Link		Dual Link		2.0 mm	
	2.4 mm	2.4 mm		2.4 mm		2.4 mm		2.4 mm		Zipcord		Zipcord		2.0 mm	
	3.0 mm	3.0 mm		3.0 mm		3.0 mm		3.0 mm		8-12 Fiber Count		8-12 Fiber Count		2.0 mm	
Applications	Telephony	Telephony		Telephony		Telephony		Telephony		Telephony		Telephony		Telephony	
	CATV/Broadband	CATV/Broadband		CATV/Broadband		CATV/Broadband		CATV/Broadband		CATV/Broadband		CATV/Broadband		CATV/Broadband	
	Telco Backplanes	Telco Backplanes		Telco Backplanes		Telco Backplanes		Telco Backplanes		Telco Backplanes		Telco Backplanes		Telco Backplanes	
	LAN/WAN	LAN/WAN		LAN/WAN		LAN/WAN		LAN/WAN		LAN/WAN		LAN/WAN		LAN/WAN	



Simplex Cable Assemblies

Simplex cable assemblies are offered with a variety of combinations. Connectors include SC, FC, ST and LC. 3.0 mm, 2.0 mm, 1.6 mm and 900 µm simplex cables in riser and plenum are available.

Features

- 3.0 mm, 2.0 mm, 1.6 mm, and 900 µm cable diameter available
- Riser, Plenum and LSZH rated cables available

Applications

- Building interconnections (campus LAN)
- Trunking lines direct to telecommunications closet
- Fiber patch panels within communications closets
- Links between electronic equipment and fiber patch panels

Cable Components

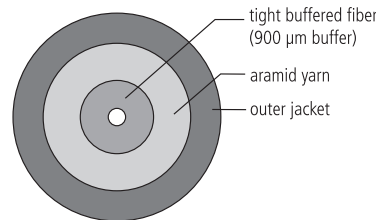

Ordering Information

ASC

Connector End A

Single-mode

ASC = Angle SC
AFC = Angle FC
ALC = Angle LC
USC = Ultra SC
UFC = Ultra FC
UST = Ultra ST
ULC = Ultra LC

Multimode

PSC = SC MM
PFC = FC MM
PLC = LC MM
PST = ST MM

ASC

Connector End B

Single-mode

ASC = Angle SC
AFC = Angle FC
ALC = Angle LC
USC = Ultra SC
UFC = Ultra FC
UST = Ultra ST
ULC = Ultra LC
XXX = No connector

Multimode

PSC = SC MM
PFC = FC MM
PLC = LC MM
PST = ST MM
XXX = No connector

RS

Cable Type

RS = 3.0 mm Riser
PS = 3.0 mm Plenum
KR = 3.0 mm I/O Riser
RT = 2.0 mm Riser
PT = 2.0 mm Plenum
RM = 1.6 mm Riser
PM = 1.6 mm Plenum
JH = 900 µm

001

Fiber Count

001 = 1

Q

Fiber Type

Q = Single-mode*
2 = Multimode 62.5/125 OM1
L = Multimode 50/125 OM3
C = Multimode 50/125 OM4

0010

Cable Length (meters)

0010 = 10 meters
(specify length)

NOTES: * All Single-mode cable assemblies use the ITU G.657.A1 standard.

Qualifications

GOVERNING BODY	STANDARD CODE	COMPONENT
Telcordia	GR-409 GR-326	Cable Connectors
RoHS	Compliant	Cable
ITU	G.652.D, G.657.A1	Single-mode optical fiber only

Contact AFL for further details.

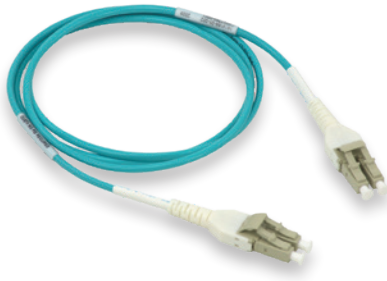

Duplex Cable Assemblies

Zipcord cables are used to meet the requirements for two-fiber cable assemblies, utilizing SC, FC, ST and LC connectors.

Features

- Flexible, 2-fiber design
- Riser, Plenum and LSZH* rated cables available (*contact AFL)

Applications

- Private networks
- Data centers
- High-density applications
- Interconnect and cross-connect
- Premise installations

Cable Components

Zipcord

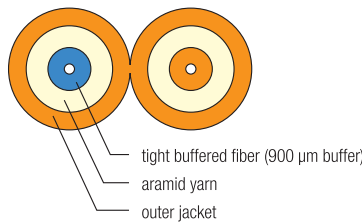

Qualifications

GOVERNING BODY	STANDARD CODE	COMPONENT
Telcordia	GR-409 GR-326	Cable Connectors
RoHS	Compliant	Cable
ITU	G.652.D, G.657.A1	Single-mode optical fiber only

Contact AFL for further details.

Ordering Information

UST	UST	RZ	002	Q	0010
Connector End A	Connector End B	Cable Type	Fiber Count	Fiber Type	Cable Length (meters)
Single-mode AFC = Angle FC UFC = Ultra FC }* UST = Ultra ST ADL = Angled LC Duplex ASF = Angled SC Duplex USF = Ultra SC Duplex UDL = Ultra LC Duplex Multimode PFC = FC MM }* PST = ST MM }* PSF = SC Duplex MM PDL = LC Duplex MM	Single-mode AFC = Angle FC UFC = Ultra FC }* UST = Ultra ST ADL = Angled LC Duplex ASF = Angled SC Duplex USF = Ultra SC Duplex UDL = Ultra LC Duplex XXX = No connector Multimode PFC = FC MM }* PST = ST MM }* PSF = SC Duplex MM PDL = LC Duplex MM XXX = No connector	Zipcord RZ = 3.0 mm Riser PZ = 3.0 mm Plenum R20Z = 2.0 mm Riser P20Z = 2.0 mm Plenum R16Z = 1.6 mm Riser P16Z = 1.6 mm Plenum	002 = 2	Q = Single-mode** 2 = Multimode 62.5/125 OM1 L = Multimode 50/125 OM3 C = Multimode 50/125 OM4	XXXX (specify length) 0010 = 10 meters

NOTES:

1. Refer to Connector Specifications page.
- * Single connector options, quantity two per end. Duplex connectors are assembled with removable clip.
 - ** All Single-mode cable assemblies use the ITU G.652.D/G.657.A1 standard.
 - *** LC Connectors available on 2.0 mm Zipcord cable.

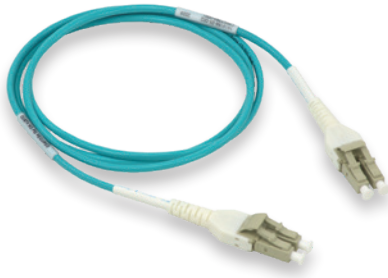

LC Uniboot Cable Assemblies

AFL's LC Uniboot cable assemblies offer a more compact design when compared to traditional duplex zipcord assemblies. These assemblies contain two LC connectors encased in a common housing with one boot, terminated on a single, round, two-fiber cable. Utilizing AFL's DUAL-Link 2.0 and 2.4 mm premise cable, LC Uniboot assemblies condense the cable management to half the space used by regular zipcord assemblies. AFL's LC Uniboot cable assemblies offer the best solution for high-density applications.

Cable Components

DUAL-Link

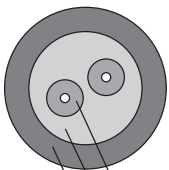

tight buffered fiber (900µm buffer)
aramid yarn
outer jacket

Features

- LC Uniboot connector uses a single housing and single boot and is field-reversible for polarity
- 2.0 and 2.4 mm DUAL-Link cable

Applications

- Private networks
- Data centers
- High density applications
- Interconnect and cross-connect
- Premise installations

Specifications

PARAMETER	VALUE
Insertion Loss (typical)	0.15 dB (SM/MM)
Return Loss (typical)	-55 dB (SM), -30 dB (MM)
Durability	500 cycles
Operating Temperature	0°C to +70°C
Ferrule	Zirconia

Ordering Information

2.0 mm Plenum DUAL-Link Cable Assemblies

FIBER TYPE	AFL NO.
Single-mode	CS011378-XXXX
Multimode 62.5/125 (OM1)	CS011381-XXXX
Multimode 50/125 (OM3)	CS010640-XXXX
Multimode 50/125 (OM4)	CS011386-XXXX

2.4 mm Plenum DUAL-Link Cable Assemblies

FIBER TYPE	AFL NO.
Single-mode	CS011389-XXXX
Multimode 62.5/125 (OM1)	CS011394-XXXX
Multimode 50/125 (OM3)	CS011397-XXXX
Multimode 50/125 (OM4)	CS011400-XXXX

XXXX = Length (meters)

Example: 0010 = 10

Qualifications

GOVERNING BODY	STANDARD CODE	COMPONENT
Telcordia	GR-326 GR-409	Connectors Cable
EIA/TIA	604-10A(FOCIS 10)	Connectors
RoHS		Cable

Contact AFL for further details.

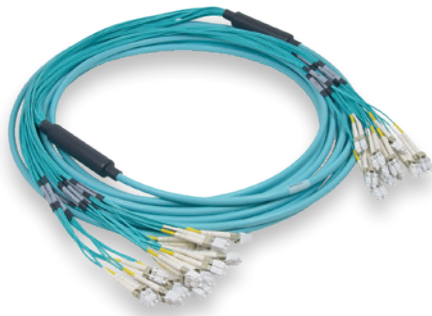
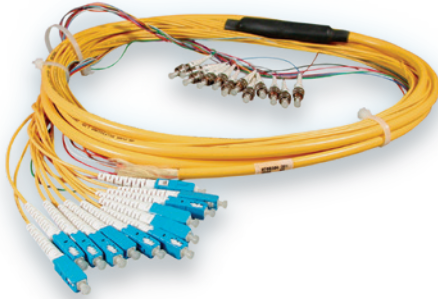

Multi-Fiber Cable Assemblies

Multi-fiber cable assemblies provide safe and cost effective installation for many applications. These assemblies help eliminate labor-intensive field termination, yet guarantee reliable performance. These assemblies feature a unified construction for easy fiber identification and rapid installation.

Features

- 4-144 fibers with aramid yarn reinforcement for rugged protection
- Available with 900 μm tight buffered fibers or sub-unitized design with twelve 250 μm fibers per tube
- Highly flexible for ease of routing
- Riser, Plenum and LSZH rated cables available
- Pre-installed pulling eye kits available on certain products

Applications

- Headend termination to a fiber "backbone"
- Termination of fiber rack systems
- Multi-floor deployment where select fibers are used at each floor
- Intra-building "backbones"
- Data center systems

Specifications

PARAMETER	SINGLE-MODE ASSEMBLIES				MULTIMODE ASSEMBLIES	
	LC		SC		LC	SC
	ULTRA	ANGLED	ULTRA	ANGLED		
Insertion Loss (Typical dB)***	0.15	0.15	0.15	0.15	0.15	0.15
Insertion Loss (Maximum dB)	0.3	0.3	0.3	0.3	0.5	0.5
Return Loss (Typical dB)***	-60	-70	-60	-70	-35	-35
Return Loss (Minimum dB)	-55	-65	-55	-65	-30	-30

*** Typical values based on equal quality connectors.

continued
→

Multi-Fiber Cable Assemblies

Ordering Information

ASC	ASC	RC	012	Q	0010	NN
Connector End A	Connector End B	Cable Type	Fiber Count	Fiber Type	Cable Length (meters)	Leg Diameter
Single-mode ASC = Angle SC AFC = Angle FC USC = Ultra SC UFC = Ultra FC UST = Ultra ST ULC = Ultra LC UDL = Ultra LC Duplex Multimode PSC = SC MM PFC = FC MM PLC = LC MM PST = ST MM PDL = LC Duplex MM* PSF = SC Duplex MM*	Single-mode ASC = Angle SC AFC = Angle FC USC = Ultra SC UFC = Ultra FC UST = Ultra ST ULC = Ultra LC XXX = No connector Multimode PSC = SC MM PFC = FC MM PLC = LC MM PST = ST MM XXX = No connector	RC = Riser (CPC) PC = Plenum (CPC) PL = Plenum MicroCore®	004 = 4 006 = 6 012 = 12 024 = 24 036 = 36 048 = 48 072 = 72 096 = 96 144 = 144	Q = Single-mode ITU G.652D/ G.657.A1 2 = Multimode 62.5/125 μm OM1 L = Multimode 50/125 μm OM3 C = Multimode 50/125 μm OM4	XXXX (specify length) 0010 = 10 meters	Leg Diameter N = 900 μm End A / XXX End B NN = 900 μm End A and B F = Furcated End A / XXX End B FF = Furcated Ends A and B FN = Furcated Ends A / 900 μm End B NF = 900 μm End A / Furcated Ends B

NOTES:

1. Refer to Connector Specifications page.
2. Duplex SC and LC available

Qualifications

GOVERNING BODY	STANDARD CODE	COMPONENT
EIA/TIA	568-A	Cable
Telcordia	GR-409-CORE GR-326	Cable Connectors
RoHS	Compliant	Cable

Temperature Specifications

Temperature Range	-40°C to +85°C
-------------------	----------------

Contact AFL for further details.



MPO Cable Assemblies



MPO Fanout Cable Assemblies

MPO Cable Assemblies

MPO cable assemblies provide a high performance plug-and-play solution for premise installations where space is a premium. Used to interconnect panels or cassettes, the small diameter MicroCore[®] cable construction reduces the required pathway space and provides a flexible outer jacket in both single-mode and multimode configurations. Multiple breakout options are also available including LC, SC, ST, or FC single fiber connectors.

Features

- High density, plug and play fiber optic interconnects
- Pre-terminated cable assemblies eliminate field termination time and guarantee optical performance
- Available with a wide variety of cable and connector options
- Standard and low loss connectors
- Single-mode and laser-optimized multimode fiber available
- Pulling eye option available upon request

Applications

- Data center systems wiring
- MPO-MPO or MPO-Fanouts
- Headend termination to a fiber "backbone"
- Termination of fiber rack systems
- Multi-floor deployment
- Intrabuilding "backbones"

Specifications

PARAMETER	SINGLE-MODE ASSEMBLIES					MULTIMODE ASSEMBLIES		
	LC		SC		MPO	LC	SC	MPO (LOW LOSS)
	ULTRA	ANGLED	ULTRA	ANGLED	ANGLED			
Insertion Loss (Typical dB) ^{***}	0.15	0.15	0.15	0.15	0.35	0.15	0.15	0.15
Insertion Loss (Maximum dB)	0.3	0.3	0.3	0.3	0.75	0.5	0.5	0.2
Return Loss (Typical dB) ^{***}	-60	-70	-60	-70	-65	-35	-35	-30
Return Loss (Minimum dB)	-55	-65	-55	-65	-55	-30	-30	-20
Operation Temperature	0°C to 70°C							
Durability Cycles	500	500	500	500	200	500	500	200

^{***} Typical values based on equal quality connectors.

MPO Cable Assemblies

Ordering Information

MPO-MPO Assemblies

(Female MPOs on both ends – no pins)

(Polarity: Key Up/Key Up, Straight Through)

FIBER COUNT	FIBER TYPE	PULLING EYE	AFL NO.
12	Single-mode, Single Jacket	No	CS017463-XXXX
12	Single-mode	No	CS009980-XXXX
12	Single-mode	Yes	CS009981-XXXX
24	Single-mode	No	CS009984-XXXX
24	Single-mode	Yes	CS009985-XXXX
72	Single-mode	No	CS009996-XXXX
72	Single-mode	Yes	CS009997-XXXX
12	50 µm 10gig 300 (OM3), Single Jacket	No	CS003695-XXXX
12	50 µm 10gig 300 (OM3)	No	CS010649-XXXX
12	50 µm 10gig 300 (OM3)	Yes	CS010650-XXXX
24	50 µm 10gig 300 (OM3)	No	CS003700-XXXX
24	50 µm 10gig 300 (OM3)	Yes	CS009912-XXXX
72	50 µm 10gig 300 (OM3)	No	CS003720-XXXX
72	50 µm 10gig 300 (OM3)	Yes	CS010016-XXXX
12	50 µm 10gig 550 (OM4), Single Jacket	No	CS013364-XXXX
12	50 µm 10gig 550 (OM4)	No	CS008420-XXXX
12	50 µm 10gig 550 (OM4)	Yes	CS010165-XXXX
24	50 µm 10gig 550 (OM4)	No	CS010100-XXXX
24	50 µm 10gig 550 (OM4)	Yes	CS010066-XXXX
72	50 µm 10gig 550 (OM4)	No	CS010101-XXXX
72	50 µm 10gig 550 (OM4)	Yes	CS010067-XXXX

NOTE: XXXX is length in meters.

Contact AFL Customer Service for additional polarity schemes available.

Qualifications

GOVERNING BODY	STANDARD CODE	COMPONENT
Telcordia	GR-326/GR-1435 GR-409-CORE	Connectors Cable
EIA/TIA	568-A	Cable

Contact AFL for further details.

MPO Fanout Assemblies

(Male MPOs — Duplex Connectors)

FIBER COUNT	FIBER TYPE	PULLING EYE	AFL NO.	
			MALE MPO-LC DUPLEX	MALE MPO-SC DUPLEX
12	Single-mode	No	CS009521-XXXX	CS010020-XXXX
12	Single-mode	Yes	CS0010017-XXXX	CS010021-XXXX
24	Single-mode	No	CS003796-XXXX	CS010022-XXXX
24	Single-mode	Yes	CS010018-XXXX	CS010023-XXXX
72	Single-mode	No	CS003811-XXXX	CS010024-XXXX
72	Single-mode	Yes	CS010019-XXXX	CS010025-XXXX
12	50 µm 10gig 300 (OM3)	No	CS011510-XXXX	CS010030-XXXX
12	50 µm 10gig 300 (OM3)	Yes	CS010027-XXXX	CS010031-XXXX
24	50 µm 10gig 300 (OM3)	No	CS003795-XXXX	CS010032-XXXX
24	50 µm 10gig 300 (OM3)	Yes	CS010028-XXXX	CS010033-XXXX
72	50 µm 10gig 300 (OM3)	No	CS003810-XXXX	CS010034-XXXX
72	50 µm 10gig 300 (OM3)	Yes	CS010029-XXXX	CS010035-XXXX
12	50 µm 10gig 550 (OM4)	No	CS009519-XXXX	CS010073-XXXX
12	50 µm 10gig 550 (OM4)	Yes	CS010068-XXXX	CS010074-XXXX
24	50 µm 10gig 550 (OM4)	No	CS010069-XXXX	CS010075-XXXX
24	50 µm 10gig 550 (OM4)	Yes	CS010070-XXXX	CS010076-XXXX
72	50 µm 10gig 550 (OM4)	No	CS010071-XXXX	CS010077-XXXX
72	50 µm 10gig 550 (OM4)	Yes	CS010072-XXXX	CS010078-XXXX

Xpress Fiber Management® (XFM®) 1RU Patch Panel

The Xpress Fiber Management (XFM) 1U patch panel is a rack mountable interconnect point specifically designed to manage dense fiber applications. Based on the LGX® intermateability platform, the panel is fully compatible with AFL's XFM Optical Cassette, Passive Optical Coupler Modules, and Poli-MOD® solutions. This panel offers enhanced management of densities up to 72 fibers using MTP-LC XFM Optical Cassettes (24 fibers).

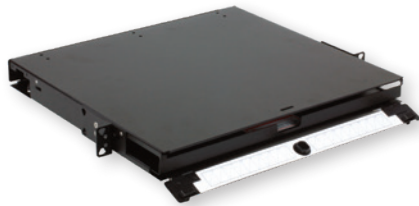

Features

- Steel construction
- Textured black powder coat finish
- Universal WECO/TIA 19"/23" rack compatibility
- (3) LGX 118 adapter plate / module mounting positions
- Slide-out tray with relief cut-outs for simplified connector access
- Optional front door key lock for heightened protection of internal components

Applications

- Data Centers
- Enterprise Networks
- Telecommunications Closets
- Central Offices / Headends

Specifications

DEPTH (A) (inches)	WIDTH (B) (inches)	HEIGHT (C) (inches)	RACK UNITS	CAPACITY	UNLOADED WEIGHT
15.5	17	1.7	1	(3) LGX 118	13 lbs.

Ordering Information

DESCRIPTION	MODEL NUMBER	AFL NO.
Xpress Fiber Management 1U Patch Panel, Black, Empty	XFM-1-U-B-0	FM002711-BE

Accessories

DESCRIPTION	AFL NO.
Kit, Lock, for CON/CNS Panels	FM001318

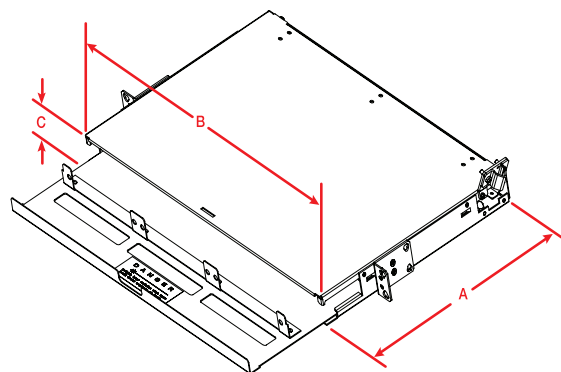

LGX is a registered trademark of Furukawa Electric North America, Inc.

Xpress Fiber Management® (XFM) 2RU Patch Panel

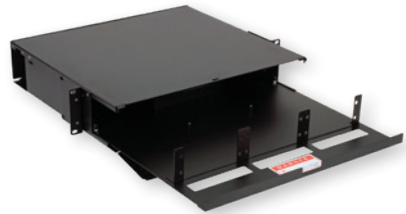

The Xpress Fiber Management (XFM) 2U patch panel is a rack mountable interconnect point specifically designed to manage dense fiber applications. Based on the LGX® intermateability platform, the panel is fully compatible with AFL's XFM Optical Cassette, Passive Optical Coupler Modules, and Poli-MOD® solutions. This panel offers enhanced management of densities up to 144 fibers using MTP-LC XFM Optical Cassettes (24 fibers).

Features

- Steel construction
- Textured black powder coat finish
- Universal WECO/TIA 19"/23" rack compatibility
- (6) LGX 118 adapter plate / module mounting positions
- Slide-out tray with relief cut-outs for simplified connector access
- Optional front door key lock for heightened protection of internal components

Applications

- Data Centers
- Enterprise Networks
- Telecommunications Closets
- Central Offices / Headends

Specifications

DEPTH (A) IN INCHES	WIDTH (B) IN INCHES	HEIGHT (C) IN INCHES	RACK UNITS	CAPACITY	UNLOADED WEIGHT
15.5	17	3.5	2	(6) LGX 118	15 lbs.

Ordering Information

DESCRIPTION	MODEL NUMBER	AFL NO.
Xpress Fiber Management 2U Patch Panel, Black, Empty	XFM-2-U-B-0	FM002712-BE

Accessories

DESCRIPTION	AFL NO.
Kit, Lock, for CON/CNS Panels	FM001318

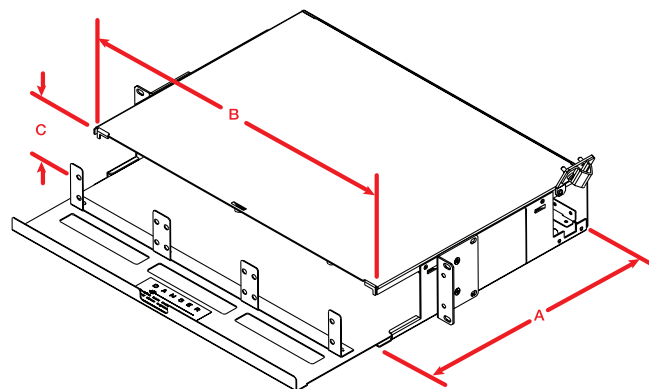

LGX is a registered trademark of Furukawa Electric North America, Inc.



Xpress Fiber Management® (XFM®) 4RU Patch Panel

The Xpress Fiber Management (XFM) 4RU patch panel is a rack mountable interconnect point specifically designed to manage dense fiber applications. Based on the LGX® intermateability platform, the panel is fully compatible with AFL's XFM Optical Cassette, Poli-MOD® and WDM solutions, offering enhanced management of densities up to 288F using MTP/MPO, single fiber, or patch and splice methodologies. Routing rings on the top and bottom of the front panel provide enhanced cable routing allowing cable assemblies to exit comfortably. This panel can be provisioned with a key lock at the time of order for secure environments.

Features

- Aluminum construction
- Textured black powder coat finish
- Universal WECO/TIA 19"/23" rack compatibility
- (12) LGX 118 adapter plate / module mounting positions
- Mounting depth adjustable from flush to 8" in 1" increments

Applications

- Data Centers
- Enterprise Networks
- Telecommunications Closets
- Central Offices / Headends

Specifications

DEPTH (A) IN INCHES	FRONT WIDTH (B) IN INCHES	REAR WIDTH (C) IN INCHES	HEIGHT (D) IN INCHES	RACK UNITS	CAPACITY	UNLOADED WEIGHT
15.5	17	15	7	4	(12) LGX 118	9 lbs.

Ordering Information

DESCRIPTION	MODEL NO.	AFL NO.
Xpress Fiber Management 4U Patch Panel, Black, Empty	XFM-4U-B-0	FM001090-B
Xpress Fiber Management 4U Patch Panel, Black, Empty, Key Lock	XFM-4U-B-K	FM001218-B

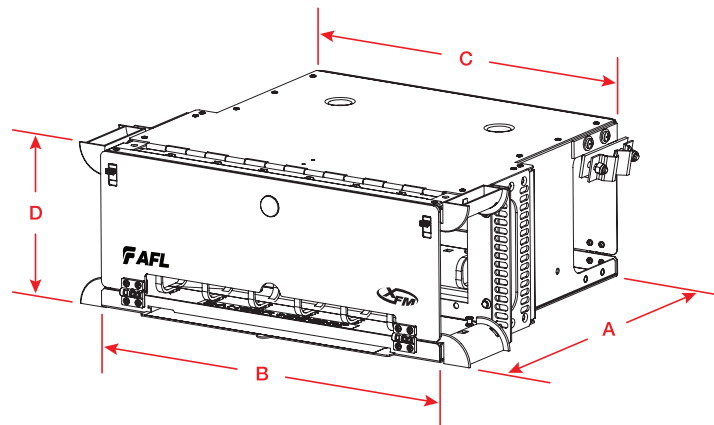

LGX is a registered trademark of Furukawa Electric North America, Inc.

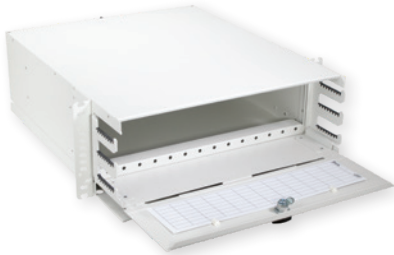

Front View—Door Open



Side Ports and Lower Pass-thru

XFM®-28 Dual Access Module Panel

AFL's XFM-28 Dual Access Module Panel is designed to maximize module capacity via both front and rear access in just four rack units.

In applications where additional rack space is unavailable, the XFM-28 doubles the capacity of traditional 14 slot, front-access only 4RU panels, offering a total of 28 slots to accommodate modules (14 front / 14 rear). The panel is lightweight yet robust, with efficient cable management features for routing flexibility.

Features

- Dual access via front and rear panel doors
- Aluminum construction
- Universal WECO/TIA 19"/23" rack compatibility
- (28) LGX® 118 module mounting positions (14 front / 14 rear)
- Cable management features include side cable ports and full pass-thru underneath the main bulkhead compartment to allow cable routing from front to back within the panel without eliminating any module positions

Specifications

DEPTH	WIDTH	HEIGHT	RACK UNITS	CAPACITY	UNLOADED WEIGHT
21 in.	17 in.	7 in.	4	(28) LGX 118	10 lbs.

Ordering Information

DESCRIPTION	MODEL NO.	AFL NO.
XFM-28, Enclosure, 4RU, 19/23"	XFM-28	FM004268

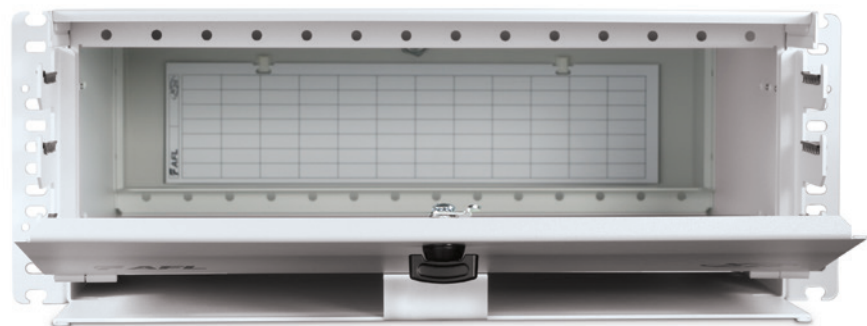



LightLink Adapter Plates

LightLink Adapter Plates add versatility to AFL's panel product line. Adapter plates are compatible with industry standard platforms allowing for easy upgrades to existing panels. Adapter Plates come preloaded with adapters and are available in 6, 8, 12 and 24 pack versions for single-fiber adapters. Higher fiber counts are achievable with multi-fiber adapters. Blank plates are also available for unused space in panels.

Features

- Metal Plate with Nylatches
- Polyurethane powder coated (white or black)
- LGX® compatible

Specifications

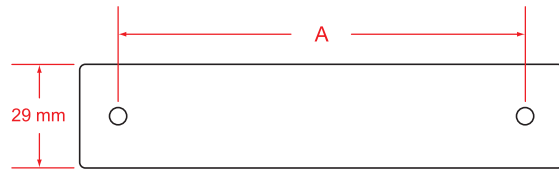

DIMENSION A
118 mm LGX®
170 mm LGX®

Ordering Information

AFL NO.	ADAPTER TYPE	SIMPLEX/DUPLEX/QUAD	ADAPTER COLOR	FIBER COUNT	PLATE HEIGHT	PLATE COLOR
BLANK						
FM003072	BLANK	BLANK	NA	0	LGX (118)	BLACK
FM003462	BLANK	BLANK	NA	0	LGX (118)	WHITE
FM000343	BLANK	BLANK	NA	0	LGX (118)	SMOOTH BLACK
FM003434	BLANK	BLANK	NA	0	LGX (170)	BLACK
FM003433	BLANK	BLANK	NA	0	LGX (170)	WHITE
SC						
FM003295	SC	DUPLEX	AQUA	12F	LGX (118)	BLACK
FM002272	SC	DUPLEX	AQUA	12F	LGX (118)	WHITE
FM003293	SC	DUPLEX	BEIGE	12F	LGX (118)	BLACK
FM002273	SC	DUPLEX	BEIGE	12F	LGX (118)	WHITE
FM003301	SC	DUPLEX	BLACK	12F	LGX (118)	BLACK
FM003297	SC	DUPLEX	BLUE	12F	LGX (118)	BLACK
FM002271	SC	DUPLEX	BLUE	12F	LGX (118)	WHITE
FM002633	SC	DUPLEX	GREEN	12F	LGX (118)	BLACK
FM002634	SC	DUPLEX	GREEN	12F	LGX (118)	WHITE
FM000149	SC	DUPLEX	BEIGE	12F	LGX (170)	WHITE
FM000148	SC	DUPLEX	BEIGE	12F	LGX (170)	BLACK
FM000144	SC	DUPLEX	BLUE	12F	LGX (170)	BLACK
FM000145	SC	DUPLEX	BLUE	12F	LGX (170)	WHITE
FM000152	SC	DUPLEX	GREEN	12F	LGX (170)	BLACK
FM000153	SC	DUPLEX	GREEN	12F	LGX (170)	WHITE
FM003287	SC	DUPLEX	AQUA	6F	LGX (118)	BLACK
FM003285	SC	DUPLEX	BEIGE	6F	LGX (118)	BLACK
FM003398	SC	DUPLEX	BEIGE	6F	LGX (118)	WHITE
FM003299	SC	DUPLEX	BLACK	6F	LGX (118)	BLACK
FM003289	SC	DUPLEX	BLUE	6F	LGX (118)	BLACK
FM003458	SC	DUPLEX	BLUE	6F	LGX (118)	WHITE
FM003283	SC	DUPLEX	GREEN	6F	LGX (118)	BLACK
FM000115	SC	DUPLEX	GREEN	6F	LGX (118)	WHITE

LGX is a registered trademark of Furukawa Electric North America, Inc.

LightLink Adapter Plates

Ordering Information (cont.)

AFL NO.	ADAPTER TYPE	SIMPLEX/DUPLEX/ QUAD	ADAPTER COLOR	FIBER COUNT	PLATE HEIGHT	PLATE COLOR
SC						
FM003120	SC	SIMPLEX	AQUA	12F	LGX (118)	BLACK
FM003118	SC	SIMPLEX	BEIGE	12F	LGX (118)	BLACK
FM003242	SC	SIMPLEX	BLACK	12F	LGX (118)	BLACK
FM003122	SC	SIMPLEX	BLUE	12F	LGX (118)	BLACK
FM002842-TW	SC	SIMPLEX	BLUE	12F	LGX (118)	WHITE
FM003116	SC	SIMPLEX	GREEN	12F	LGX (118)	BLACK
FM000800-TW	SC	SIMPLEX	GREEN	12F	LGX (118)	WHITE
FM003411	SC	SIMPLEX	BEIGE	12F	LGX (170)	WHITE
FM003409	SC	SIMPLEX	BLUE	12F	LGX (170)	BLACK
FM003407	SC	SIMPLEX	BLUE	12F	LGX (170)	WHITE
FM003414	SC	SIMPLEX	GREEN	12F	LGX (170)	BLACK
FM003455	SC	SIMPLEX	GREEN	12F	LGX (170)	WHITE
FM003098	SC	SIMPLEX	AQUA	6F	LGX (118)	BLACK
FM003096	SC	SIMPLEX	BEIGE	6F	LGX (118)	BLACK
FM003403	SC	SIMPLEX	BEIGE	6F	LGX (118)	WHITE
FM003238	SC	SIMPLEX	BLACK	6F	LGX (118)	BLACK
FM003100	SC	SIMPLEX	BLUE	6F	LGX (118)	BLACK
FM003467	SC	SIMPLEX	BLUE	6F	LGX (118)	WHITE
FM003094	SC	SIMPLEX	GREEN	6F	LGX (118)	BLACK
FM000480	SC	SIMPLEX	GREEN	6F	LGX (118)	WHITE
FM000156	SC	SIMPLEX	BLUE	8F	LGX (118)	BLACK
FM003435	SC	SIMPLEX	BLUE	8F	LGX (118)	WHITE
FM002841	SC	SIMPLEX	GREEN	8F	LGX (118)	BLACK
FM000158	SC	SIMPLEX	GREEN	8F	LGX (118)	WHITE
LC						
FM001004	LC	DUPLEX	GREEN	12F	LGX (118)	WHITE
FM001303	LC	DUPLEX	AQUA	12F	LGX (118)	WHITE
FM003108	LC	DUPLEX	GREEN	12F	LGX (118)	BLACK
FM003110	LC	DUPLEX	BEIGE	12F	LGX (118)	BLACK
FM003112	LC	DUPLEX	AQUA	12F	LGX (118)	BLACK
FM001185	LC	QUAD	AQUA	12F	LGX (118)	BLACK
FM000297	LC	DUPLEX	BLUE	12F	LGX (170)	WHITE
FM000298	LC	DUPLEX	BLUE	12F	LGX (170)	BLACK
FM000301	LC	DUPLEX	GREEN	12F	LGX (170)	WHITE
FM000302	LC	DUPLEX	GREEN	12F	LGX (170)	BLACK
FM000838	LC	DUPLEX	BLUE	24F	LGX (118)	WHITE
FM000851	LC	DUPLEX	BEIGE	24F	LGX (118)	WHITE
FM000853	LC	DUPLEX	AQUA	24F	LGX (118)	WHITE
FM003069	LC	DUPLEX	GREEN	24F	LGX (118)	WHITE
FM001184	LC	QUAD	AQUA	24F	LGX (118)	BLACK
FM000129	LC	DUPLEX	BLUE	24F	LGX (170)	WHITE
FM000130	LC	DUPLEX	BLUE	24F	LGX (170)	BLACK
FM000338	LC	DUPLEX	GREEN	24F	LGX (170)	WHITE
FM000339	LC	DUPLEX	GREEN	24F	LGX (170)	BLACK
FM000348	LC	DUPLEX	BEIGE	24F	LGX (170)	WHITE
FM000349	LC	DUPLEX	BEIGE	24F	LGX (170)	BLACK
FM000289	LC	DUPLEX	BLUE	6F	LGX (118)	WHITE
FM000293	LC	DUPLEX	GREEN	6F	LGX (118)	WHITE
FM000294	LC	DUPLEX	GREEN	6F	LGX (118)	BLACK
FM003092	LC	DUPLEX	BLUE	6F	LGX (118)	BLACK
FM003429	LC	DUPLEX	BEIGE	6F	LGX (118)	WHITE
FM004252	LC	DUPLEX	AQUA	6F	LGX (118)	BLACK

LightLink Adapter Plates

Ordering Information (cont.)

AFL NO.	ADAPTER TYPE	SIMPLEX/DUPLEX/ QUAD	ADAPTER COLOR	FIBER COUNT	PLATE HEIGHT	PLATE COLOR
LC						
FM003240	LC	DUPLEX	BLACK	12F	LGX (118)	BLACK
FM003425	LC	DUPLEX	BLUE	12F	LGX (118)	WHITE
FM003465	LC	DUPLEX	BLUE	12F	LGX (118)	BLACK
FM003202	LC	DUPLEX	GREEN	24F	LGX (118)	BLACK
FM003204	LC	DUPLEX	BEIGE	24F	LGX (118)	BLACK
FM003206	LC	DUPLEX	AQUA	24F	LGX (118)	BLACK
FM003208	LC	DUPLEX	BLUE	24F	LGX (118)	BLACK
FM003244	LC	DUPLEX	BLACK	24F	LGX (118)	BLACK
ST						
FM003126	ST	SIMPLEX	METAL SM/MM	12F	LGX (118)	BLACK
FM003456	ST	SIMPLEX	METAL SM/MM	12F	LGX (118)	WHITE
FM000286	ST	SIMPLEX	METAL SM/MM	12F	LGX (170)	BLACK
FM000285	ST	SIMPLEX	METAL SM/MM	12F	LGX (170)	WHITE
FM003104	ST	SIMPLEX	METAL SM/MM	6F	LGX (118)	BLACK
FM003422	ST	SIMPLEX	METAL SM/MM	6F	LGX (118)	WHITE
FM003102	ST	SIMPLEX	METAL SM/MM	6F	LGX (118)	BLACK
FM003441	ST	SIMPLEX	METAL SM/MM	8F	LGX (118)	BLACK
FM003439	ST	SIMPLEX	METAL SM/MM	8F	LGX (118)	WHITE
FC						
FM000284	FC	SIMPLEX	METAL	12F	LGX (118)	BLACK
FM000283	FC	SIMPLEX	METAL	12F	LGX (118)	WHITE
FM003447	FC	SIMPLEX	METAL	12F	LGX (170)	BLACK
FM003446	FC	SIMPLEX	METAL	12F	LGX (170)	WHITE
FM003420	FC	SIMPLEX	METAL, GREEN DUST CAP	6F	LGX (118)	BLACK
FM003419	FC	SIMPLEX	METAL, GREEN DUST CAP	6F	LGX (118)	WHITE
FM003443	FC	SIMPLEX	METAL	8F	LGX (118)	BLACK
FM003442	FC	SIMPLEX	METAL	8F	LGX (118)	WHITE
MISC						
FM003210	HEYCO	SIMPLEX	BLACK	12F	LGX (118)	BLACK
FM003430	MTP	SIMPLEX	BLACK	36F	LGX (118)	BLACK
FM003212	HEYCO	SIMPLEX	BLACK	6F	LGX (118)	BLACK
FM003437	SC-ST HYBRID	SIMPLEX	BLUE-METAL	6F	LGX (118)	WHITE
FM001606	MTP	SIMPLEX	BLACK	72F	LGX (118)	BLACK
FM003005	MTP	SIMPLEX	BLACK	96F	LGX (118)	BLACK

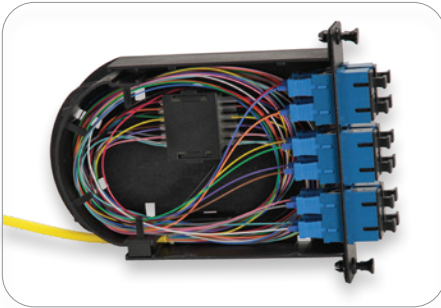

12-Fiber SC/UPC Configuration



24-Fiber LC/UPC Configuration



DAS Poli-MOD



Poli-MOD® Patch and Splice Module

AFL's new Poli-MOD is an innovative patch and splice module, which offers an inventive and effective means to accommodate up to 24 fiber interconnections in an industry-standard, single-slot LGX® 118 footprint. The Poli-MOD offers a unique and robust way to secure cable without the need for time-wasting, tie-wrap alternatives. Additionally, the module leverages a creative snap-in splice sleeve cradle to securely manage both single and ribbon fiber arrangements. These features provide the capacity to outfit a standard 4RU rack-mount panel with up to 288-fiber interconnections.

The Poli-MOD is also offered in an arrangement that supports the low loss budget requirements of Distributed Antenna System (DAS) networks. This is accomplished through the elimination of an interconnection point while providing a robust splicing environment for rack and wall-mount panel applications.

Features

- 24-fiber interconnection capacity
- LGX 118 compatibility (single-slot module)
- Effective and time-saving cable mounting mechanism (no tie-wraps necessary)
- Inventive splice sleeve cradle
- Available in SC, LC, ST and FC connector arrangements
- Shuttered LC connectors for increased dust protection
- Organized fiber routing
- Fixed solution, no moving parts
- Multi-directional cable entry access
- DIN rail mountable (with DIN Mount Kit)

Applications

- Telecommunications Closets
- Data Centers
- Customer Premise
- Local Area Networks
- Wide Area Networks
- Central Offices
- Hub Sites
- Cabinets
- Remote Terminals
- Distributed Antenna Systems (DAS)

LGX is a registered trademark of Furukawa Electric North America, Inc.

Poli-MOD® Patch and Splice Module

Ordering Information

Example: PM-L-12-ASC-0-S-01

PM	L	12	ASC	0	S	01
	Configuration	Fiber/Connector Count	Connector Type ³	Fiber Type	Fiber Arrangement	Packaging
	E = Empty (Splicing Only) H = Half Loaded (Adapter Plate only) L = Loaded (Adapter Plate & Pigtails) D = DAS Poli-MOD ¹	06 = 6 Fibers/Connectors 12 = 12 Fibers/Connectors 24 = 24 Fibers/Connectors ² XX = Empty	ASC = Angle-Polished SC USC = Ultra-Polished SC PSC = Multimode SC ALC = Angle-Polished LC ULC = Ultra-Polished LC PLC = Multimode LC UST = Ultra-Polished ST PST = Multimode ST AFC = Angle-Polished FC UFC = Ultra-Polished FC PFC = Multimode FC XXX = Empty	0 = Single-mode (G.657.A1 BIF) 1 = 62.5 μm (OM1) 2 = 50 μm (OM2) 3 = 50 μm (OM3) 4 = 50 μm (OM4) X = Empty	S = Single/Standard R = Ribbon 3 = 3 mm, 3 meter DAS W = SpiderWeb Ribbon® (SWR®) X = No Fiber (Half Loaded or Empty)	01 = 1 Poli-MOD per box* 06 = 6 Poli-MODs per box 12 = 12 Poli-MODs per box

1. DAS Poli-MOD, with a maximum of 12 fibers each, requires specialty packaging and is packaged as "1 Poli-MOD per box" ONLY.
2. 24 Fibers/Connectors are only available in a LC Duplex configuration.
3. Angle and Ultra-Polished connector types are only available with single-mode fiber configurations.

Adapter Color Codes

FIBER AND POLISH TYPE	ADAPTER COLOR
Single-mode, APC (Angled Physical Contact)	Green
Single-mode, UPC (Ultra Physical Contact)	Blue
Multimode OM1, PC (Physical Contact)	Beige
Multimode OM2, PC (Physical Contact)	Black
Multimode OM4, PC (Physical Contact)	Aqua

Poli-MOD Kits/Accessories

DESCRIPTION	AFL NO.
Poli-MOD Cable Mounting Clip Kit	FM003053
Poli-MOD Spiral Wrap Kit	FM003280
Poli-MOD Splice Chip Kit with 24 Splice Sleeves	FM003711
Fusion Splice Sleeve, FP-03, 40 mm	S000206
Adapter Bracket for Mounting Single Poli-MOD, angled	FM000948-B
Adapter Bracket for Mounting Single Poli-MOD, flat	FM003589-B
Corning CCH and PCH 145 mm Adapter Bracket	FM001636
DIN Mount Kit, LGX® 118	FM003394

Dimensions

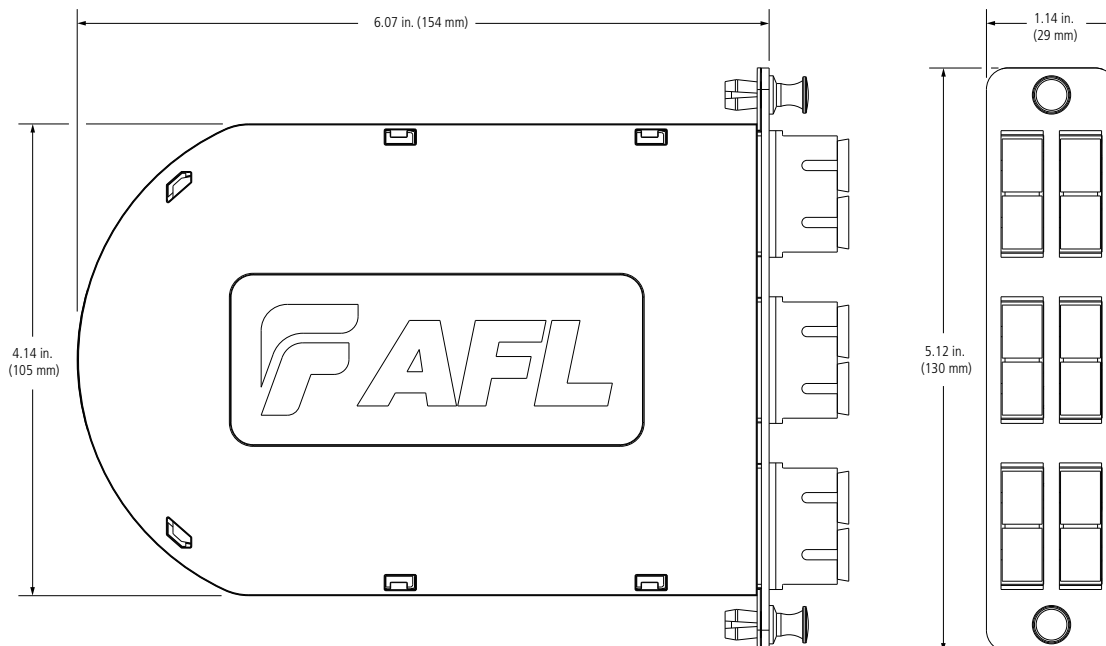

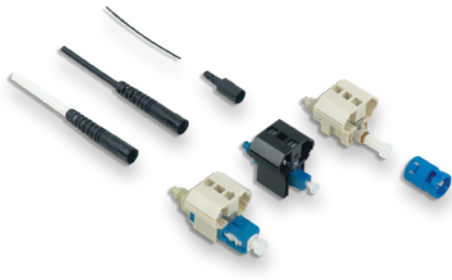

Features

- No epoxy, no Polish
- Low insertion loss
- Fiber can be reinserted up to three times
- 4.8 mm (SC only) cordage compatibility
- VFI accessory to confirm proper installation

Applications

- Premise/Enterprise Networks
- LAN/WAN Connections
- Patch Panels
- Equipment Termination
- FTTx Applications
- Field Repair/Replacement
- Equipment Test Leads

FASTConnect® Field-Installable Connectors

FASTConnect are factory pre-polished, field-installable connectors that completely eliminate the need for hand polishing in the field. Proven mechanical splice technology ensuring precision fiber alignment, a factory pre-cleaved fiber stub and a proprietary index-matching gel combine to offer an immediate low loss termination to either single-mode or multimode optical fibers. FASTConnect are compatible with 250 μm and 900 μm optical fibers, as well as 4.8 mm (SC only) cordage.

All primary fiber types are supported, and each connector is color coded per industry standard requirements to aid in identification during and after installation. A factory-installed wedge clip (included with each connector) is removed and discarded upon completion of the termination. Incorporated into this device is an innovative, translucent wedge enabling the use of a common VFI to provide a "pass/fail" signal once physical contact is achieved.

Specifications

PARAMETER	TYPE	VALUE
Insertion Loss:	Single-mode - UPC	Average: 0.2 dB, Maximum: 0.5 dB
	Single-mode - APC	Average: 0.3 dB, Maximum: 0.6 dB
	Multimode - PC	Average: 0.1 dB, Maximum: 0.5 dB
Return Loss at Room Temperature	Single-mode - UPC	Average: -50 dB, Maximum: -45 dB
	Single-mode - APC	Average: -55 dB, Maximum: -50 dB
	Multimode	Average: -25 dB, Maximum: -20 dB

Ordering Information

FIBER TYPE	HOUSING COLOR	CABLE SIZE	AFL NO.	
			PACKAGE OF 6	PACKAGE OF 100
FASTCONNECT SC				
Multimode 62.5/125 μm, OM1	Beige	900 μm	FAST-SC-MM62.5-6	FAST-SC-MM62.5-100
Multimode 50/125 μm, OM2	Black		FAST-SC-MM50-6	FAST-SC-MM50-100
Multimode 50/125 μm, OM3/OM4 compatible	Aqua		FAST-SC-MM50L-6	FAST-SC-MM50L-100
Single-mode, UPC	Blue		FAST-SC-SM-6	FAST-SC-SM-100
Single-mode, APC	Green		FAST-SC-SMAU-6	FAST-SC-SMAU-100
Single-mode, APC	Green	4.8 mm	FAST-SC48-SMAU-6	FAST-SC48-SMAU-100
FASTCONNECT ST				
Multimode 62.5/125 μm, OM1	Beige	900 μm	FAST-ST-MM62.5-6	FAST-ST-MM62.5-100
Multimode 50/125 μm, OM2	Black		FAST-ST-MM50-6	FAST-ST-MM50-100
Multimode 50/125 μm, OM3/OM4 compatible	Aqua		FAST-ST-MM50L-6	FAST-ST-MM50L-100
Single-mode, UPC	Blue		FAST-ST-SM-6	FAST-ST-SM-100
FASTCONNECT LC				
Multimode 62.5/125 μm, OM1	Beige	900 μm	FAST-LC-MM62.5-6	FAST-LC-MM62.5-100
Multimode 50/125 μm, OM2	Black		FAST-LC-MM50-6	FAST-LC-MM50-100
Multimode 50/125 μm, OM3/OM4 compatible	Aqua		FAST-LC-MM50L-6	FAST-LC-MM50L-100
Single-mode, UPC	Blue		FAST-LC-SM-6	FAST-LC-SM-100
Single-mode, APC	Green		FAST-LC-SMAU-6	FAST-LC-SMAU-100

continued



FASTConnect® Field-Installable Connectors

Accessories

DESCRIPTION			AFL NO.	AFL NO.
BOOT KITS FOR 2 MM AND 3 MM CORDAGE	COLOR	CABLE SIZE	PACK OF 6	PACK OF 100
2 mm Boot Kit, SC/LC/ST	Black	2 mm	FAST-BOOT-2MM-6	FAST-BOOT-2MM-100
3 mm Boot Kit, SC/LC/ST	Black	3 mm	FAST-BOOT-3MM-6	FAST-BOOT-3MM-100
DUPLEX CLIPS				
LC Duplex Clip (LC only)	Transparent		CS010437-06	CS010437-100
TOOL KITS				AFL NO.
FASTConnect High Precision Tool Kit with CT50 Cleaver				CS001201
FASTConnect High Precision Tool Kit with CT16 Cleaver				CS010975
VISUAL FAULT IDENTIFIERS				AFL NO.
VFI4 visual fault identifier with 2.5 mm and 1.25 mm adapters				VFI4-01-0900PR
2.5 mm Universal for VFI port				2900-50-0013MR
1.25 mm Universal for VFI port				2900-50-0012MR

Qualifications

GOVERNING BODY	STANDARD CODE
EIA/TIA	568-C.3 604 (FOCIS)

Temperature Specifications

TEMPERATURE RANGE	
Operating Temperature	-40°C to +75°C

Patents

COUNTRY	PATENT NUMBER(S)
U.S.	5,963,699 5,984,532 6,179,482 7,003,208 7,258,496

Contact AFL for further details.



Tool Kit Contents

FASTConnect® Universal Tool Kit

Now available with the CT50 or CT16 Cleaver!

The FASTConnect Universal Tool Kits provide all the necessary installation tools required for fiber preparation of 250 μm or 900 μm fibers, or 900 μm, 2 mm or 3 mm cordage for AFL's pre-polished FASTConnect. Featuring either the CT50 or CT16 fiber cleaver, the FASTConnect Universal Tool Kit contains all the industry standard termination tools required for fiber preparation. Additionally, the carrying case has adequate storage for extra FASTConnects for on-site convenience.

Kit Features

- Industry standard fiber preparation tools
- Compact design, flexible yet rugged case
- Complete instructions provided

Applications

- Premise environments
- LAN Fiber to the Desk environments
- Patch panel/wiring closets
- FTTx applications
- Quick repair/replacement areas



CT50 Cleaver

Ordering Information

DESCRIPTION	AFL NO.
FASTConnect High Precision Tool Kit with CT50 Cleaver	CS001201
FASTConnect High Precision Tool Kit without cleaver	CS001201-NC
FASTConnect High Precision Tool Kit with CT16 Cleaver	CS010975

Tool Kits include: Cleaver, FAST Assembly Tool, 3 mm Cable Clamp, 2 mm Cable Clamp, 0.25/0.9 mm Cable Clamp, Fiber Stripper, Kevlar Scissors, Fiber Preparation Fluid, Lint-free Cloth Wipes, Marker Pen, Installation Instructions, Strip Length Template and a Carrying Case.



CT16 Cleaver

CT50 Cleaver Features

- Motorized blade rotation
- Bluetooth communication
- Shock resistant
- Simple one-step operation
- 60,000 cleave blade life
- Field serviceable

CT16 Cleaver Features

- Dual fiber adapter plate for single or two fiber cleaving
- Ambidextrous operation available
- Field replaceable fiber clamp pads and cleaver blade
- Shock resistant for drops up to 30" in any of six different orientations
- Compact form factor and tool-less blade rotations



FUSEConnect Connectors (SC, FC, LC, ST)

FUSEConnect® Fusion-Spliced, Field-Installable Connectors

AFL's FUSEConnect fusion-spliced, field installable connectors are uniquely designed and feature only four to five components. The factory pre-polished ferrule eliminates the need for polishing, adhesives, and crimping in the field, which minimizes the potential for operator error and expensive connector scrap.

FUSEConnect utilizes a fusion splicer to terminate the connector in the field, addressing return loss concerns present in analog optical networks. This advanced process yields true APC performance for SC/APC and LC/APC configurations. FUSEConnect is compatible with Fujikura fusion splicers and most other fiber holder-based fusion splicing platforms.

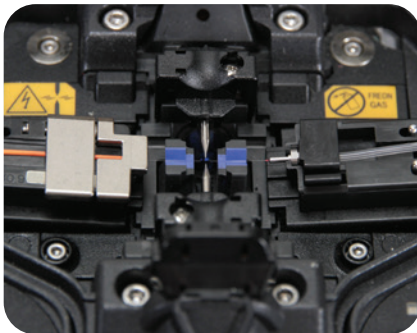

FUSEConnect in Fusion Splicer

Features

- Field installable
- No adhesives, crimping or polishing
- True APC performance
- Compatible with most fusion splicers

Applications

- Connectorization in:
 - RF-overlay FTTP networks
 - Cable TV backbone networks
 - Outside plant
 - FTTD
 - MDU FTTP Cabling
- Central office connector replacement
- Data center installation

Specifications

PARAMETER	VALUE
Connector Type	SC, LC, FC, ST
Cable Type	900 μm, 2 mm, 3 mm, 4.8 mm (SC only)
Polish	APC, UPC, PC
Insertion Loss	SM: 0.15 dB (average), 0.25 dB (maximum) / MM: 0.10 dB (average), 0.25 dB (maximum)
Return Loss	SM: ≤ -65 dB (APC), ≤ -55 dB (UPC) / MM: ≤ -35 dB (PC)

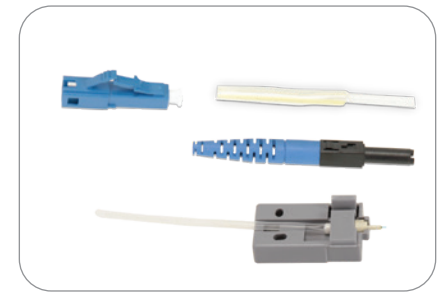
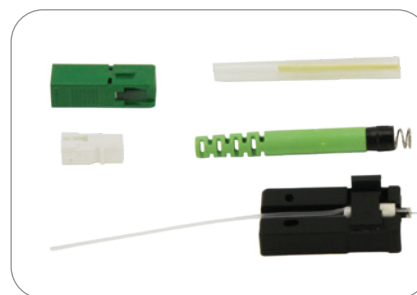
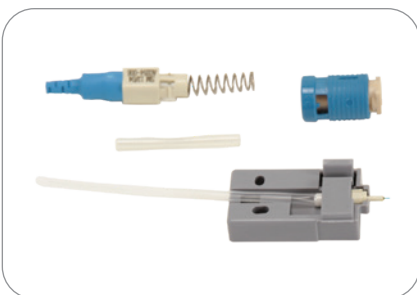

FUSEConnect Kits—ST (blue), SC (green), LC (blue)

continued
→

FUSEConnect® Fusion-Spliced, Field-Installable Connectors

Ordering Information

CONNECTOR TYPE	BOOT TYPE	AFL NO.*				
		UPC SM (Blue)	APC SM (Green)	PC 62.5 μm MM (Beige)	PC 50 μm MM (Black)	PC 50 μm LOMMF (AQUA) **
SC	900 μm	FUSE-SC9SMU-6	FUSE-SC9SMA-6	FUSE-SC9M62-6	FUSE-SC9M50-6	FUSE-SC9M50L-6
	3 mm	FUSE-SC3SMU-6	FUSE-SC3SMA-6	FUSE-SC3M62-6	FUSE-SC3M50-6	FUSE-SC3M50L-6
	4.8 mm	—	FUSE-SC48SMA-6	—	—	—
LC	900 μm	FUSE-LC9SMU-6	FUSE-LC9SMA-6	FUSE-LC9M62-6	FUSE-LC9M50-6	FUSE-LC9M50L-6
	2 mm	FUSE-LC2SMU-6	FUSE-LC2SMA-6	FUSE-LC2M62-6	FUSE-LC2M50-6	FUSE-LC2M50L-6
FC	900 μm	FUSE-FC9SMU-6	FUSE-FC9SMA-6	FUSE-FC9M62-6	FUSE-FC9M50-6	FUSE-FC9M50L-6
	2 mm	FUSE-FC2SMU-6	—	FUSE-FC2M62-6	FUSE-FC2M50-6	FUSE-FC2M50L-6
	3 mm	FUSE-FC3SMU-6	—	FUSE-FC3M62-6	FUSE-FC3M50-6	FUSE-FC3M50L-6
ST	900 μm	FUSE-ST9SMU-6	—	FUSE-ST9M62-6	FUSE-ST9M50-6	FUSE-ST9M50L-6
	2 mm	FUSE-ST2SMU-6	—	FUSE-ST2M62-6	FUSE-ST2M50-6	FUSE-ST2M50L-6
	3 mm	FUSE-ST3SMU-6	—	FUSE-ST3M62-6	FUSE-ST3M50-6	FUSE-ST3M50L-6

* AFL NO. is for one pack of 6 pieces

** Laser Optimized MM Fiber (LOMMF) compatible with OM3 and OM4 fibers

Temperature Specifications

TEMPERATURE RANGE	
Operating Temperature	-40°C to +75°C

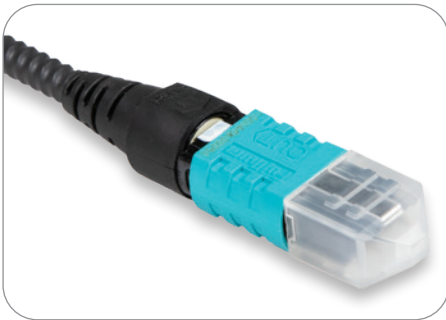

FUSEConnect MPO Connectors, Cable



FUSEConnect MPO Connectors, Ribbon

FUSEConnect® MPO Splice-On, Field-Installable Connectors with Heat Sleeve

AFL's FUSEConnect MPO splice-on, field-installable connectors are uniquely designed and feature just six components. The innovative factory pre-polished ferrule allows for a field-termination process that eliminates the need for polishing, adhesives and crimping in the field and minimizes the potential for operator error and expensive connector scrap. FUSEConnect MPO is part of the FUSEConnect splice-on connector family which includes SC, LC, ST and FC style connectors.

This updated design for the FUSEConnect MPO replaces the mechanical clamp splice protector with a heat protection sleeve utilizing the on-board splicer heater eliminating the need for a separate mechanical clamp tool. The connector is designed for use with the new RT-02 ribbonizing tool which does not require ribbonizing glue resulting in a cleaner termination process.

FUSEConnect MPO performs as an equivalent to the standard factory terminated MPO/MTP® assemblies. Designed to utilize standard ribbon, SpiderWeb Ribbon®, or loose tube cable, this connector helps minimize the complexity involved in the termination of a multi-fiber connection, allowing for a reliable and repeatable termination in field applications. AFL offers a tool kit as well as a variety of accessories designed to meet all your installation needs for your FUSEConnect MPO application.

Features

- Field installable splice-on connector
- Heat sleeve style splice protector
- Utilizes RT-02 ribbonizing tool for glueless termination process
- Only six components
- No adhesives, crimping or polishing
- Field MPO polarity customization
- Includes 3.0 mm round and flat ribbon boots in each pack

Applications

- Connectorization in:
 - RF-overlay FTTP networks
 - Cable TV backbone networks
 - Outside plant
 - MDU FTTP Cabling
- Connector restoration in the field
- Data center installation
- Patch cord customization in the field

Specifications

PARAMETER		VALUE
Insertion Loss	Single-mode (OS1)	Average: 0.25 dB; Max: 0.75 dB
	Single-mode (OS1), Low Loss	Average: 0.10 dB; Max: 0.35 dB
	62.5/125 (OM1)	Average: 0.10 dB; Max: 0.35 dB
	50/125 (OM4)	Average: 0.10 dB; Max: 0.35 dB
Return Loss	Single-mode (OS1)	>65 dB
	62.5/125 (OM1)	>30 dB
	50/125 (OM4)	>30 dB

continued
→

FUSEConnect® MPO Splice-On, Field-Installable Connectors with Heat Sleeve

Ordering Information

AFL NO.*	CONNECTOR TYPE	FIBER TYPE	POLISH	CABLE SIZE		HOUSING COLOR
				ROUND	FLAT	
FUSEMPO-S-SMA-3-F-6	MPO, Female (No Guide Pins)	Single-mode (OS1)	APC	3.0 mm	250 µm	Green
FUSEMPO-S-SMA-3-M-6	MPO, Male (Guide Pins)	Single-mode (OS1)	APC	3.0 mm	250 µm	Green
FUSEMPO-S-LSMA-3-F-6	MPO, Female (No Guide Pins)	Single-mode (OS1), Low Loss	APC	3.0 mm	250 µm	Mustard
FUSEMPO-S-LSMA-3-M-6	MPO, Male (Guide Pins)	Single-mode (OS1), Low Loss	APC	3.0 mm	250 µm	Mustard
FUSEMPO-S-MM6-3-F-6	MPO, Female (No Guide Pins)	Multimode 62.5 µm (OM1)	PC	3.0 mm	250 µm	Beige
FUSEMPO-S-MM6-3-M-6	MPO, Male (Guide Pins)	Multimode 62.5 µm (OM1)	PC	3.0 mm	250 µm	Beige
FUSEMPO-S-OM4-3-F-6	MPO, Female (No Guide Pins)	Multimode , 50 µm (OM4)	PC	3.0 mm	250 µm	Aqua
FUSEMPO-S-OM4-3-M-6	MPO, Male (Guide Pins)	Multimode , 50 µm (OM4)	PC	3.0 mm	250 µm	Aqua

*Pack of 6 pieces

Ordering Information – Accessories

DESCRIPTION	AFL NO.
TOOL KIT	
FUSEConnect MPO Tool Kit	FUSEMPO-TL-KT
ACCESSORIES	
FUSEConnect Stripping Tool (3.0 mm, 2.8 mm, 2.0 mm and 1.6 mm)	FUSE-ST-TL
FUSEConnect MPO Heater Attachment Tool	FUSE-HT-TL
MPO Boot Kit for 3.8 mm diameter cable (Pack of 144)	FUSEMPO-BOOT-3.8MM-144
MPO Boot Kit for Jacketed Ribbon (Pack of 6)	FUSEMPO-BOOT-JK-6

Temperature Specifications

TEMPERATURE RANGE	
Operating Temperature	-40°C to +75°C

Qualifications

GOVERNING BODY	STANDARD CODE
TIA	604-5-C
IEC	61754-7
EIA/TIA	568-C.3
FOCIS	FOCIS-5

Contact AFL for further details.



LightLink 580 Optical Splicing and Distribution Enclosure

The LightLink (LL) 580 Optical Splicing and Distribution Enclosure provides for organizing, splicing and interconnecting fibers in broadband, distribution and building entrance applications. The splice tray panel is equipped with LGX® 118 footprint snaps so various types of connectors may be installed. The enclosure features a scratch resistant powder coated base and a fully gasketed hinged cover. The cover was designed so that it may be installed on either side of the enclosure where there are space restrictions. The internal interconnect tray and back-plate may be removed from the enclosure and brought to a splicing table to complete splicing, fiber routing and fiber management. The cable entry base has four interchangeable configurations to allow the installation of cable through a grommet system, or through pre-installed conduit couplings.

Features

Enclosure

- Independent cable strain-relief for flat drop cable and 2 mm/3 mm drops
- Unique self-sealing grommet system
- Self-contained inner chassis frame with separate outer housing
- Dual telco can-wrench locking fasteners
- Hinged cover securable with standard padlock
- Internal, owner-accessible security screw
- Available with a variety of connector types and cable entrance choices

Interconnect Splice Tray Kit

- Included: (2) Factory Pre-installed LL-7644 Universal Splice Tray with SC-UPC 900 µm pigtails for up to 72 connections. LC-UPC Duplex adapters may be installed for up to 144 LC connections with mass fusion.
- Interconnect Tray may be purchased with either SC-UPC adapters and pigtails preinstalled or LC-UPC Duplex adapters and pigtails pre-installed.

Specifications

PARAMETER	VALUE
Material – Housing	16 Gauge Aluminum
Coating	Electrostatically applied powder paint
Color	Beige
Size (H x W x D in.)	27.5" x 13.0" x 5.625" (total length: 33.5" L x 13")
Weight (lbs)	15.2
Adapters	(72) SC or (72) LC Duplex
Splice	(2) LL-7644 up to 120 single fused fibers or 24 mass fusion sleeves (2) LL-4808 L-R up to 72 single fused fibers or 24 mass fusion sleeves

continued →

LightLink 580 Optical Splicing and Distribution Enclosure

Ordering Information

DESCRIPTION	AFL NO.
LL-580 Enclosure Base (No Bottom Plate or LGX® Tray)	FM002814
Interconnect Trays	
Kit, Splice/4x LGX® Interconnect Tray, with (2) LL-7644 Trays	FM002858-001
Kit, Splice/4x LGX® Interconnect Tray, 24 SCU, with (2) LL-7644 Trays	FM002858-SCU
Kit, Splice/4x LGX® Interconnect Tray, 24 SCA, with (2) LL-7644 Trays	FM002858-SCA
Kit, Splice/4x LGX® Interconnect Tray, 24 LCU, with (2) LL-7644 Trays	FM002858-LCU
Splice Trays	
LL-7644 Splice Tray used with LGX® Interconnect Tray	FA000044
LL-4808 L-R Splice Tray used with LGX® Interconnect Tray	FA000037
Plate Kits	
Plate Kit (2 – 2 in. NPT and 2 – 1 in. KO)	FM002653
Plate Kit (2 – Single Cable Grommets [L&R] and 2 – Multiport Grommets [Center])	FM001937
Plate Kit (2 – Single Cable Grommets [L&R])	FM003014
Plate Kit (1 – 2 in. NPT and 4 – 1 in. NPT)	FM001959
Plate Kit (3 – KO)	FM003023
Grommet and NPT Kits	
1 in. NPT Kit (2 – 1 in NPT Fittings and cable hardware to be used with FM002653)	FM003015
2 in. NPT Kit (2 – 2 in NPT Fittings and cable hardware to be used with FM003023)	FM003016
Dual Cable Grommet Kit (2/kit)	911386-00-01
Accessories	
Conduit Skirt	FM002895
Pre-configured Base Enclosures and Interconnect Tray	
LL-580, 24F SC/UPC Interconnect Kit, 24F SC/UPC Pigtail Kit, (2) LL-7644 Splice Trays, No Bottom Plate	FM003248
LL-580, 48F SC/UPC Interconnect Kit, 48F SC/UPC Pigtail Kit, (2) LL-7644 Splice Trays, No Bottom Plate	FM003249
LL-580, 72F SC/UPC Interconnect Kit, 72F SC/UPC Pigtail Kit, (2) LL-7644 Splice Trays, No Bottom Plate	FM003250
LL-580, Interconnect Kit, No Adapter Plates, No Pigtail Kit, (2) LL-7644 Splice Trays, No Bottom Plate	FM003251

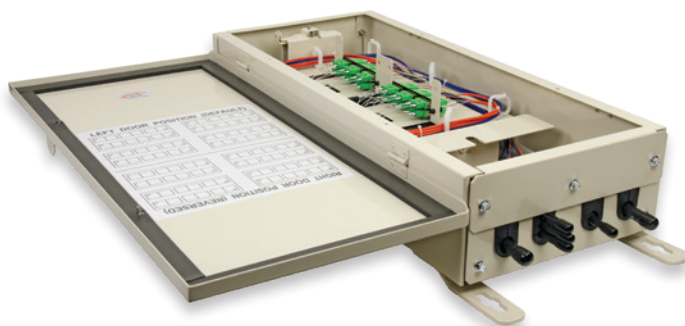

LL-580 Enclosure shown with the Cable Grommet Bottom Plate installed

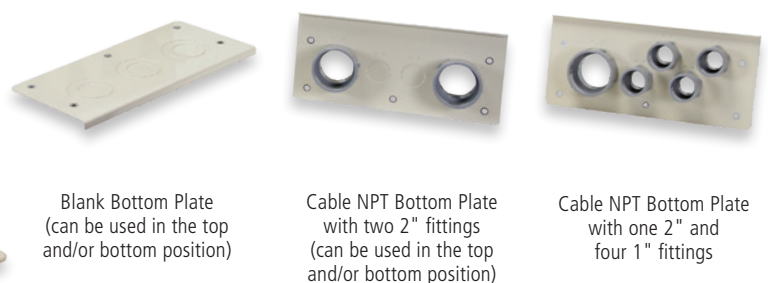

Blank Bottom Plate
(can be used in the top and/or bottom position)

Cable NPT Bottom Plate with two 2" fittings
(can be used in the top and/or bottom position)

Cable NPT Bottom Plate with one 2" and four 1" fittings

Qualifications

GOVERNING BODY	STANDARD CODE
NEMA	Type 3
Telcordia	GR-2898

Contact AFL for further details.



LightLink 550 Optical Splicing and Distribution Enclosure

The LightLink (LL) 550 Optical Splicing and Distribution Enclosure provides for organizing, splicing and interconnecting fibers in broadband, distribution and building entrance applications. The splice tray panel is equipped with LGX® 118 footprint snaps so various types of connectors may be installed. The enclosure features a scratch resistant powder coated base and a fully gasketed hinged cover. The internal interconnect tray and back-plate may be removed from the enclosure and brought to a splicing table to complete splicing, fiber routing and fiber management. The cable entry base allows for the installation of cable through a grommet system, and can be coupled to either a fixed 12 inch slack storage skirt or a telescoping 24 to 36 inch skirt.

Features

Enclosure

- Independent cable strain-relief for flat drop cable and 2 mm / 3 mm drops
- Unique self-sealing grommet system
- Self-contained inner chassis frame with separate outer housing
- Dual telco can-wrench locking fasteners
- Hinged cover securable with standard padlock
- Internal, owner-accessible security screw
- Available with a variety of connector types and cable entrance choices

Interconnect Splice Tray Kit

- Available with (2) Factory Pre-installed LL-4808 Universal Splice Trays with SC/APC or SC/UPC 900 μm pigtailed for up to 48 connections.
- Interconnect Tray may be purchased separately to upgrade existing splice-only units to accept LGX-118 adapter plates.

Specifications

PARAMETER	VALUE
Material – Housing	16 Gauge Aluminum
Coating	Electrostatically applied powder paint
Color	Beige
Size (H x W x D in.)	(H x W x D in.) 18" x 9" x 5.25" (total length 22" including mounting brackets)
Weight (lbs)	7.5
Adapters	Up to (48) SC
Splice	Connectorized: Up to (2) LL-4808 L-R up to 72 single fused fibers or 24 mass fusion sleeves
	Splice-only: Up to (4) LL-4808 L-R up to 144 single fused fibers or 48 mass fusion sleeves

continued



LightLink 550 Optical Splicing and Distribution Enclosure

Ordering Information

DESCRIPTION	AFL NO.
Base Enclosures and Interconnect Tray	
LL-550, 24F SC/APC Interconnect Kit, 24F SC/APC Pigtail Kit, (2) LL-4808 Splice Trays, 4 Grommet Bottom Plate	FM004181
LL-550, 48F SC/APC Interconnect Kit, 48F SC/APC Pigtail Kit, (2) LL-4808 Splice Trays, 4 Grommet Bottom Plate	FM004182
LL-550, Splice-only Security Cover, (2) LL-4808 Splice Trays, 4 Grommet Bottom Plate	FM004183
LL-550, 24F SC/UPC Interconnect Kit, 24F SC/UPC Pigtail Kit, (2) LL-4808 Splice Trays, 4 Grommet Bottom Plate	FM004214
LL-550, 48F SC/UPC Interconnect Kit, 48F SC/UPC Pigtail Kit, (2) LL-4808 Splice Trays, 4 Grommet Bottom Plate	FM004215
LL-550 LGX-118 Interconnect Tray (for upgrading splice-only to accept LGX-118 adapter plates)	FM004216
Splice Trays	
LL-4808 L-R Splice Tray used with LGX® Interconnect Tray	FA000037
Grommet and NPT Kits	
1 in. NPT Kit (2 – 1 in NPT Fittings and cable hardware to be used with FM004177)	FM003015
2 in. NPT Kit (2 – 2 in NPT Fittings and cable hardware to be used with FM004177)	FM003016
Dual Cable Grommet Kit (2/kit)	911386-00-01
Accessories	
Fixed Conduit Skirt	FM004177
Telescoping Skirt	FM004072



LL-550 Fixed Skirt



LL-550 Telescoping Skirt

Qualifications

GOVERNING BODY	STANDARD CODE
NEMA	Type 3
Telcordia	GR-2898

Contact AFL for further details.

FlexScan® FS200 Single-mode OTDR

Pocket-sized, Performance-packed, User-friendly, and Affordable



Features

- Flexpress® mode completes OTDR tests in <5 seconds
- Test up to 1:64 PON with 25 m PON dead zone
- Easy to understand LinkMap® results with pass/fail indications
- Single, dual or triple wavelength single-mode
- Single port for in- and out-of-service OTDR tests
- Integrated source, power meter, VFL (visual fault locator)
- Integrated MPO Switch control via USB
- Rugged, lightweight, hand-held for field use
- Available with field-replaceable Port Saver connector

Applications

- PON or point-to-point network verification or troubleshooting
- OTDR testing plus insertion loss and power measurements
- Locate faults exceeding industry or user pass/fail thresholds
- Visually pinpoint location of macro-bends or breaks

AFL's FlexScan FS200 OTDR is an all-in-one solution for detecting, identifying, locating, and resolving single-mode optical network issues. It is designed for both novice and expert technicians working in a range of environments, from FTTH PON to point-to-point networks. It applies industry-standard or user-set pass/fail criteria and displays results using LinkMap color-coded icons to show the health of the network. FlexScans automate test setup, shorten test time, and simplify results interpretation improving efficiency and reducing costs.

All-in-one test capability: The FlexScan FS200 includes an integrated VFL, power meter, and light source. It can be easily paired to AFL's award-winning FOCIS family of inspection scopes, ensuring technicians have everything they need to locate and quickly resolve optical network issues.

Performance-packed: With SmartAuto multi-pulse acquisition, up to 37 dB dynamic range, and best-in-class 25 m PON dead zone, FlexScan FS200 PON OTDRs test FTTH PONs up to 1:64 while still detecting and measuring events only meters apart.

Fast! Flexpress mode completes dual-wavelength tests in <5 seconds – 10 x faster than conventional OTDRs! For multi-fiber testing, FS200s automatically control AFL's MFS Multi-Fiber Switch (12-fiber MPO switch) to further reduce multi-fiber test time.

Pocket-sized: At 3.5 x 6 x 1.75 in. (86 x 160 x 43 mm) and less than one pound (0.4 kg), FlexScan FS200 OTDRs truly fit in your pocket, yet still provide a large, bright indoor/outdoor touchscreen display, and all-day operation.

Multiple sharing and reporting options: Results can be stored internally, saved to a USB, and uploaded via USB cable, Bluetooth (via FlexApp) or Wi-Fi for real-time reporting using the included FlexReports Test Results Manager software.

Convenient cost-saving kits: Bundle the FlexScan FS200 with your choice of launch cable, FOCIS Flex connector inspection probe and tips, and/or AFL's universal optical fiber identifier (OFI-BIPMe) for significant cost-savings!

PON-optimized FTTH-PRO kits combine FS200-303/304 with a FOCIS Flex Inspection probe, 4 adapter tips, and launch cables for both SC/APC and LC/APC networks.

Field-replaceable Port Saver connector: With AFL's optional field-replaceable Port Saver, avoid expensive service repairs to replace connectors damaged due to poor cleaning practices and/or normal wear-and-tear.

FlexScan® FS200 Single-mode OTDR

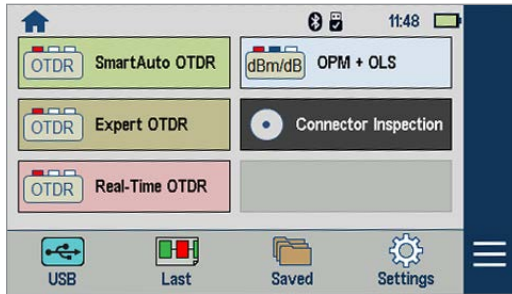

Dramatically Reduces Test Time

In SmartAuto mode, FlexScan OTDRs automatically analyze and test the network using a variety of network-optimized settings to precisely locate, characterize and identify network events with one button push. Loss and reflectance are measured for connectors, splices, splitters and macro-bends. FlexScan even checks for live fiber and verifies OTDR launch quality before initiating a test.

FlexScan's Flexpress mode completes dual-wavelength tests in seconds, reducing test time by 10x compared to conventional OTDRs. For multi-fiber testing, FlexScan's automatically control AFL's MPO Switch, testing 12 fibers at the touch of a single button.

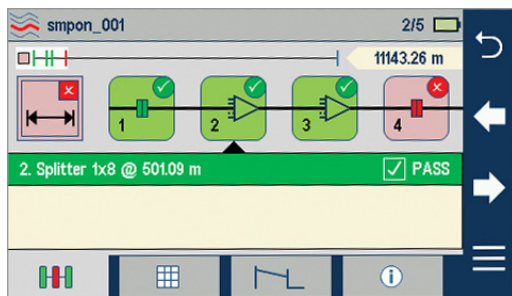

Simplifies Network Troubleshooting

LinkMap with pass/fail enables even novice users to easily and accurately troubleshoot optical networks. LinkMap presents an icon-based view of the tested network clearly identifying fiber start, end, connectors, splices, PON splitters, and macro-bends.

A LinkMap summary provides end-to-end link length, loss and ORL. Loss and reflectance are displayed with clear pass/fail indications. Users can instantly toggle between LinkMap and Trace views.



Connectivity

FlexScan OTDRs easily pair with AFL's ward-winning FOCIS® family of connector inspection probes for fast, easy single-fiber and/or multi-fiber connector end-face inspection.

FlexScan results can then be transferred via USB cable, Wi-Fi, or Bluetooth and the free FlexApp running on a mobile device for real-time reporting using the included FlexReports Test Results Manager PC-based software. This real-time monitoring can help avoid mistakes in the field that will require future truck rolls.

OTDR, OLTS, and VFL Testing with a Single Tool

FlexScan optionally includes a Wave ID optical light source (OLS) and optical power meter (OPM). With Wave ID, the OPM auto-synchronizes to a single or multi-wavelength Wave ID optical signal transmitted by an AFL light source. The OPM reports detected wavelengths and measures power and loss at each wavelength, saving significant test time and eliminating setup errors.

The integrated VFL's eye-safe red laser enables users to visually pinpoint the location of macro-bends and fiber breaks often found in splice closures and fiber cabinets.

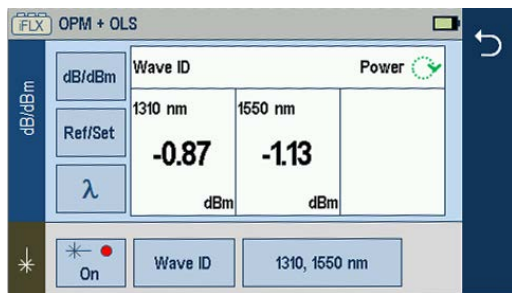

FlexScan® FS200 Single-mode OTDR

FlexScan OTDRs are available with 1310/1550/1625, 1310/1550/1650, 1310/1550, and 1650 nm only wavelengths. The 1310 and 1550 nm versions are available with integrated optical light source (OLS), optical power meter (OPM), visual fault locator (VFL) and Bluetooth/Wi-Fi.

Specifications^a

MODEL: FS200-XXX	-60	-100	-300	-303	-304
OTDR					
Emitter Type	Laser				
Safety Class ^b	Class I				
Fiber Type	Single-mode				
Wavelengths (nm)	1650	1310/ 1550	1310/ 1550	1310/ 1550/ 1625	1310/ 1550/ 1650
Center λ Tolerance ^c	1310/1550/1650: ± 20 nm; 1625 +30/-5 nm				
Dynamic Range ^d (dB)	37	32/30	37/35	37/35/37	37/35/37
Event Dead Zone ^e (m)	0.8	0.8	0.8	0.8	0.8
Atten. Dead Zone ^f (m)	3.5	3.6	3.5	3.5	3.5
PON Dead Zone ^g (m)	30	N/A	25/25	25/25/40	25/25/40
Max Split Ratio	1:64 (FS200-60/30x only); N/A (FS200-100)				
Pulse Widths	3, 5, 10, 20, 30, 50, 100, 200, 300, 500 ns; 1, 2, 3, 10 μs; 20 μs (FS200-300/300/304 only)				
Range Settings	250 m to 240 km				
Data Points	Up to 300,000 (Expert mode .SOR file)				
Data Spacing	5 cm to 16 m				
Index of Refraction	1.3000 to 1.7000				
Distance Uncertainty	±(1 + 0.003% x distance + data point spacing) m				
Linearity (dB/dB)	±0.05				
Trace File Format	Telcordia SR-4731 Issue 2 compatible .SOR				
Trace Storage Medium	4 GB internal memory (> 5000 traces typical); External USB memory stick				
Data Transfer to PC	USB cable or Bluetooth® (option)				
OTDR Modes	SmartAuto, Expert, Real-time				
Flexpress Fast Test	FS200-300/303/304				
Display Modes	LinkMap Summary, LinkMap Events, Trace				
Refresh Rate	Up to 4 Hz (Real-time mode)				
Live Fiber Protection	No OTDR damage with input power ≤ +15 dBm for wavelength(s) in range 1260 to 1675 nm				
Live Fiber Detection	Reports live fiber with input signal ≥ -35 dBm for wavelength(s) in range 1260 to 1675 nm				
PON Filter Isolation	>50 dB for 1260 nm ≤ wavelength ≤ 1600 nm				
Live PON OTDR Test	1625 or 1650 nm using filtered detector when interfering downstream power in range 1600-1675 nm <-38 dBm				

Notes:

- All specifications valid at 25 °C unless otherwise specified.
- FDA 21 CFR 1040.10 & 1040.11, IEC 60825-1: 2014.
- Using 10 ns pulse width.
- SNR=1, longest range and pulse width, 3-minute averaging.
- Maximum distance between two points 1.5 dB down each side of a reflective peak caused by an event with reflectance ≤ -45 dB using 3 or 5 ns pulse.
- Maximum distance from the start of a trace spike caused by an event with a -45 dB (or smaller) reflectance, to the point where the trace returns to and stays within ±0.5 dB of backscatter. Test pulse width is 3 or 5 ns.
- Recovery to within 0.5 dB of backscatter after 1:16 splitter (≤13 dB loss) using 50 ns pulse width.
- Max temperature while charging is +45 °C.

MODEL: FS200-XXX	-60	-100	-300	-303	-304
VISUAL FAULT LOCATOR (VFL)					
Emitter Type	Visible red laser, 650 ±20 nm				
Safety Class ^b	Class II				
Output Power	0.8 mW into single-mode fiber (-1 dBm ±0.5 dB)				
Modes	CW, 2 Hz flashing				
OPTICAL LASER SOURCE - OLS (Optional)					
Emitter Type	Laser				
Safety Class ^b	Class I				
Fiber Type	Single-mode				
Wavelengths (nm)	N/A	1310/ 1550	1310/ 1550	1310/ 1550	1310/ 1550
Center λ Tolerance	±20 nm (CW mode)				
Spectral Width (FWHM)	5 nm (maximum)				
Internal Modulation	270 Hz, 330 Hz, 1 kHz, 2 kHz, CW, Wave ID				
Wave ID	Compatible with AFL OPM/OLS				
Output Power Stability	≤ ±0.1 dB (15 minutes); ≤ ±0.15 dB (8 hours)				
Output Power	-3 dBm ±1.5 dB				
OPTICAL POWER METER -OPM (Optional)					
Calibrated Wavelengths	1310, 1490, 1550, 1625, 1650 nm				
Detector Type	InGaAs, 1 mm diameter				
Measurement Range	+23 to -50 dBm				
Tone Detect Range	+3 to -35 dBm				
Accuracy	±0.25 dB				
Resolution	0.01 dB				
Measurement Units	dB, dBm or Watts (nW, μW, mW)				
GENERAL					
Size (in boot)	86 x 160 x 43 mm				
Weight	0.4 kg				
Operational Temperature ^h	-10 °C to +50 °C, 0 to 95 % RH (non-condensing)				
Storage Temperature	-40 °C to +70 °C, 0 to 95 % RH (non-condensing)				
Power	Rechargeable Li-Pol or AC adapter				
Battery Life	>12 hours, Telcordia test conditions				
Display	4.3 in color touchscreen LCD, 480x272, backlight				
USB Ports	1 host; 1 micro-USB function				
Bluetooth (optional)	Compatible with Windows PC, Android				
Wi-Fi	Download results & update software via IEEE 802.11 Wi-Fi				

FlexScan® FS200 Single-mode OTDR

Ordering Information

All kits include a FlexScan FS200 with AC charger, battery, carry strap, SC/2.5 mm connector adapters, FlexReports, USB cable, and carry case.

FS200-XXX-Basic, Plus, PRO, BIPM Kits Order Entry: **FS200-[MOD]-[KIT]-[PW]-[C]-[CC]-[LNG]-[AC]-[FR]-[TIP]**

FS200-XXX-MPO Kits Order Entry: **FS200-[MOD]-MPO-P1-W1-[C]-[LNG]-[AC]-[MPOC]**

FS200-303/304-FTTH PRO Kits Order Entry: **FS200-[MOD]-FTTH-PRO-[CC]-[LNG]-[AC]** where:

[MOD]	FS200 FlexScan OTDR Configuration
60	1650 nm filtered Live PON Troubleshooting OTDR
100	1310/1550 nm Verification and Troubleshooting OTDR
300	1310/1550 Pt-to-Pt & PON Verification and Troubleshooting OTDR
303	1310/1550/1625 Pt-to-Pt and PON Verification and Troubleshooting OTDR
304	1310/1550/1650 Pt-to-Pt and PON Verification and Troubleshooting OTDR

[KIT]	FS200 FlexScan Kit Configuration / Kit Contents
BAS	Includes: FS200, FlexReports Basic, USB cable ^a , soft case
PLUS	Includes: BAS Kit plus 150 m SMF Fiber Ring, One-Click Cleaner, upgrade to FlexReports Advanced, soft or hard carry case
PRO	Includes: PLUS Kit plus FOCIS Flex with two user-selected adapter tips
FTTH-PRO	Includes: BAS Kit, 150 m SC/APC & LC/APC Fiber Rings, FOCIS Flex, SC/APC & LC/APC bulkhead and ferrule adapters, SC & LC One-Click Cleaners, Port Saver, FlexReports Advanced, soft or hard carry case (FS200-303/304 only)
BIPM	Includes: PRO Kit plus OFI-BIPMe
MPO	Includes: FlexScan plus MFS Multi-Fiber Switch, MPO launch cable, OTDR-to-Switch patch cord, OTDR-to-Switch USB cable, FlexReports Advanced

[PW]	Power Meter / Wireless Option
P0-W0	No Source, Power Meter, or Bluetooth/WiFi (FS200-60/100 only)
P0-W1 ^b	No Source or Power Meter; Includes Bluetooth/WiFi (FS200-300/304 only)
P1-W0	No Bluetooth/WiFi (-303/304 only); Includes Source, Power Meter
P1-W1 ^b	Includes Source, Power Meter, Bluetooth/Wi-Fi

[C]	OTDR / Source Connector Type
A	APC (recommended)
U	UPC (available in all models except FS200-60)

[CC] ^c	Carry Case Option (PLUS, PRO, FTTH-PRO, BIPM Kits)
S1	Large soft case for FS200, fiber ring, FOCIS Flex, OFI-BIPMe, accessories
S2	Medium soft case for FS200, fiber ring, FOCIS Flex, accessories
H1	Hard carry case for FS200, fiber ring, FOCIS Flex, OFI-BIPMe, accessories

[LNG]	Language
ENG	English
CHS	Chinese Simplified
CHT	Chinese Traditional
CZE	Czech
DEU	German
DNK	Danish
FIN	Finnish
FRA	French
ITA	Italian

[LNG]	Language
JPN	Japanese
KOR	Korean
NOR	Norwegian
POL	Polish
POR	Portuguese
SPA	Spanish
TUR	Turkish
VNM	Vietnamese

[AC]	Destination Country	AC Plugs
US	USA	2-pin, US
EU	European Union	2-pin, EU
UK	United Kingdom	3-pin, UK
CN	China, Australia	2-pin, SAA

[FR]	150 m SMF Fiber Ring
Absent	N/A in Basic Kits
USC/USC	FR-SMF-150-USC-USC
USC/UFC	FR-SMF-150-USC-UFC
USC/ULC	FR-SMF-150-USC-ULC
USC/UST	FR-SMF-150-USC-UST
USC/ASC	FR-SMF-150-USC-ASC
USC/AFC	FR-SMF-150-USC-AFC
USC/ALC	FR-SMF-150-USC-ALC
USC/UE2	FR-SMF-150-USC-UE2
ASC/UFC	FR-SMF-150-ASC-UFC
ASC/ULC	FR-SMF-150-ASC-ULC
ASC/UST	FR-SMF-150-ASC-UST
ASC/ASC	FR-SMF-150-ASC-ASC
ASC/AFC	FR-SMF-150-ASC-AFC
ASC/ALC	FR-SMF-150-ASC-ALC
ASC/AE2	FR-SMF-150-ASC-AE2

[TIP]	FOCIS Flex Tips and Cleaning (PRO only)
Blank	Option not available in Basic & PLUS Kits
SC	SC-UPC bulkhead tip, 2.5 mm UPC ferrule tip, 2.5 mm cleaning
FC	FC-UPC bulkhead tip, 2.5 mm UPC ferrule tip, 2.5 mm cleaning
LC	LC-UPC bulkhead tip, 1.25 mm UPC ferrule tip, 1.25 mm cleaning
ASC	SC-APC bulkhead tip, 2.5 mm APC ferrule tip, 2.5 mm cleaning
AFC	FC-APC bulkhead tip, 2.5 mm APC ferrule tip, 2.5 mm cleaning
ALC	LC-APC bulkhead tip, 1.25 mm APC ferrule tip, 1.25 mm cleaning

[MPOC]	MPO Launch Cable Network Connector
F	Female (unpinned) to Female (unpinned)
M	Female (unpinned) to Male (pinned)

Notes:

- Results can be transferred from FlexScan OTDR to FlexReports using USB cable, or performed wirelessly (W1 option) after downloading free FlexApp. The FlexApp is available as a free download from 'Google play' or 'App Store'.
- FlexScans equipped with Bluetooth option (W1) support Bluetooth transfer of results via FlexApp for remote reporting using FlexReports.
- Basic Kit always ships with S2 (Medium Soft Case); MPO Kit always ships with MPO-specific soft case.

FlexScan® FS200 Single-mode OTDR

Ordering Information

Accessories

DESCRIPTION	AFL NO.
FlexScan wrist strap	1400-05-0230PZ
FlexScan neck strap, 36"	1400-05-0231PZ
AC charger 100-240 VAC to 5 VDC	4050-00-0931PR
Soft carry case for FS200 kits with FOCIS Flex and Fiber Ring	1400-01-0111PZ
Soft carry case for FS200 kits with FOCIS Flex, OFI-BIPMe and Fiber Ring	1400-01-0128PZ
Hard carry case for FS200 kits with FOCIS Flex, OFI-BIPMe and Fiber Ring	1400-01-0134PZ
Vehicle charger, 12VDC to 5VDC @2A	4050-00-0033MR
Cable, USB-micro B, 5 pin, 6'	6000-00-0031MR
5V USB charging cable (1.5 m), type A to barrel (0.9 X 3.2 X 9 mm)	6000-00-0034PR
One-Clicks, fluid, wipes, etc. See www.AFLglobal.com	Cleaning Supplies

Field-Replaceable OTDR Connector (Optical Ferrule Port Saver)

Protect your OTDR ports from damage due to mating with dirty or damaged launch cables or patch cords or normal wear-and-tear. Equip your FlexScan FS200 with a field-replaceable connector, which installs in seconds and accepts AFL's tool-free interchangeable SC, LC, FC and ST connector adapters.

Replace damaged connectors in the field: When normal wear-and-tear or poor cleaning practices damage the port saver's end-face, replace it in seconds without having to return the OTDR to a service center for an expensive and time-consuming repair.

DESCRIPTION	AFL NO.
FlexScan-facing APC female to APC male field-replaceable Port Saver connector	2900-58-0001MR
FlexScan-facing APC female to UPC male field-replaceable Port Saver connector	2900-58-0002MR
FlexScan-facing UPC female to APC male field-replaceable Port Saver connector	2900-58-0003MR
FlexScan-facing UPC female to UPC male field-replaceable Port Saver connector	2900-58-0004MR

Connector Adapters

CONNECTOR ADAPTER	AFL NO.		
	OTDR/OLS PORT	OPM PORT	VFL PORT
FC	2900-50-0002MR	2900-52-0001MR	N/A
SC	2900-50-0003MR	2900-52-0002MR	N/A
ST	2900-50-0004MR	2900-52-0003MR	N/A
LC	2900-50-0006MR	2900-52-0004MR	N/A
SC/APC	2900-50-0011MR	2900-52-0002MR	N/A
2.5 mm Universal	N/A	2900-52-0005MR	2900-50-0007MR
1.25 mm Universal	N/A	2900-52-0006MR	2900-50-0010MR

FlexScan® FS200 Single-mode OTDR

Test Management and Reporting Software

DESCRIPTION	AFL NO.
FlexReports Advanced, one seat license on USB	RPTS-AD-USB-1
FlexReports Advanced, one seat, Upgrade from TRM® 3 Advanced on USB. Users must have TRM-3 Advanced license	RPTS-UP-TRM3-1
FlexReports Basic, available for download on AFL Software Resources website	FlexReports Basic
FlexApp data transfer mobile App, available on Google Play and Apple App Store	FlexApp

Recommended Products



FOCIS Flex and FOCIS Lightning (Multi-Fiber) Connector Inspection

- Self-contained, tether-free, hand-held inspection solution
- Auto-focus and auto-centering for fast, easy inspection
- IEC, IPC and user-defined pass/fail analysis
- FOCIS Lightning: extremely fast multi-fiber auto-analysis for datacom and telecom inspection applications



OFI-BIPMe Optical Fiber Identifier

- Works on all fiber types including BIF
- Trigger lock, positive stop for optimum detection
- Integrated optical power meter

Qualifications

CATEGORY	REGULATION/STANDARD	QUALIFICATION
CE Marking	EU	Compliant to relevant EU Directives on health, safety, and environmental protection, and certified with CE marking
Safety/EMC/EMI	IEC	Compliant to IEC 61010-1 for safety requirements for electrical equipment
	EN	Compliant to EN 61010-1 for safety requirements for electrical equipment
	IEC	Compliant to IEC 61326-1 for EMC requirements for electrical equipment
	EN	Compliant to EN 61326-1 for EMC requirements for electrical equipment
	EN	Compliant to EN 55011 for EMC requirements for industrial, scientific and medical equipment
	Telcordia	Compliant to GR-196-CORE 4.5.1 for requirements on electromagnetic interference
	FCC	Compliant to code of federal regulations FCC 47 CFR 15 on unlicensed transmissions
	FDA	Compliant to code of federal regulations FDA 21 CFR 1040.10 and 1040.11 on laser products
RoHS	IEC	Compliant to IEC 60825-1 for safety of laser products
	EU	Compliant to EU regulations Directive 2011/65/EU (RoHS 2) and Directive 2015/863 (RoHS 3)
Test Method	TIA	Compliant to TIA-568.3-D for test and measurement requirements for premises optical fiber cabling and components
	IEC	Compliant to IEC 11801 for test and measurement requirements for optical fiber cabling for use within premises
	AS/NZS	Compliant to AS/NZS 3080 for test and measurement requirements for optical fiber cabling for use within premises
	TIA	Compliant to TIA-526-7 for test procedures for installed optical fiber cable plant
	TIA	Compliant to TIA-526-14 for test procedures for installed optical fiber cable plant
	IEC	Compliant to IEC 14763-3 for systems and methods for the inspection and testing of installed optical fiber cabling
	AS/NZS	Compliant to AS/NZS 14763.3 for systems and methods for the inspection and testing of installed optical fiber cabling
	IEC	Compliant to IEC 61280-4-1 for test procedures for installed optical fiber cable plant
Generic Requirement	IEC	Compliant to IEC 61280-4-2 for test procedures for installed optical fiber cable plant
	Telcordia	Compliant to GR-196-CORE for generic requirements for OTDR-type equipment
	Telcordia	Compliant to SR-4731 Issue 2 for OTDR data format
	IEC	Compliant to IEC 61746-1 for requirements on calibration of OTDR

Contact Sales@AFLglobal.com to schedule a demonstration or learn how to buy.

Visit www.AFLglobal.com/Test to learn more about FlexScan FS200 OTDR.

International Sales and Service Contact Information available at www.AFLglobal.com/Test/Contacts

FOCIS Flex – Fiber Optic Connector Inspection System

Easy, Fast, Compact, Tether-free

U.S. Patent 9,217,688



Features

- 1-button to auto-focus, center, capture, analyze, and save
- IEC, IPC, and user-defined pass/fail analysis
- Untethered, compact, hand-held inspection
- Use independently or pair with OTDR
- Save 10K results internally or share via WiFi or USB

Applications

- Inspect connectors on patch cords or in bulkhead adapters
- Optical network installation, troubleshooting, and maintenance
- Inspect MPO/MTP multi-fiber connectors
- Assure critical fiber infrastructure performs properly
- Keep fiber connections working at optimal performance levels
- Verify proper connector cleaning practices are being used

FOCIS Flex makes connector inspection simple, fast, and convenient. With the press of a single button, FOCIS Flex auto-focuses, captures and centers the end-face image, applies Pass/Fail rules, displays image and Pass/Fail results, saves results internally and/or wirelessly transfers data to a paired FlexScan OTDR or a smart device. It is fast, small, and easy to use to enable 100% connector inspection.

Independent, untethered operation: With rechargeable battery and integrated display, FOCIS Flex can be used independently without requiring an external OTDR or display unit.

Optional pairing with FlexScan OTDR or smart devices: Captured images and Pass/Fail results can be immediately displayed and easily saved on either paired FlexScan OTDR or a smart device equipped with the AFL's free FOCIS Flex App. This capability enables inspection results to be included in reporting and archiving.

Save results internally or externally: FOCIS Flex internally stores up to 10,000 results using file-naming capabilities similar to those of the FlexScan OTDR. A micro-USB port supports fast upload of internally stored results to PC and ensures your FOCIS Flex software can be updated to the latest features and supported languages.

Wide range of adapter tips: Interchangeable adapter tips support connector inspection for a wide range of both single-fiber and multi-fiber patchcords and bulkhead-mounted connectors having either PC or APC polished end-faces.

Bundled kits for significant savings: FOCIS Flex is available in kits that include a Basic license for Test Result Manager (TRM® 3.0), user-selected adapter tips and cleaning supplies, and a soft carry case.

Easy reporting and archiving: Included Test Result Manager (TRM 3.0) provides data processing and reporting locally via a PC. The FOCIS Flex mobile App is available for free download from Google play or App Store for sharing data with smart devices.

FOCIS Flex – Fiber Optic Connector Inspection System

Easy, Fast, Compact, Tether-free

U.S. Patent 9,217,688

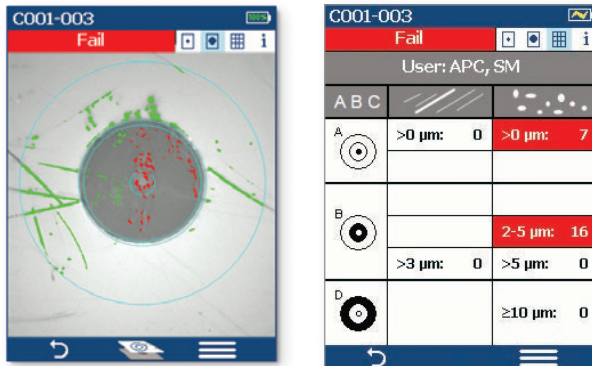

Pass/Fail results in seconds: With the press of a single button, FOCIS Flex auto-focuses, captures and centers the end-face image, applies Pass/Fail rules, displays image and Pass/Fail results. Captured Pass/Fail results are easily viewed in either Image or Table view.

Image view shows end-face image with Pass/Fail region overlay, failing scratches/defects highlighted in red, and passing scratches/defects highlighted in green.

Table view shows analysis rule applied to determine Pass/Fail, analysis Zone IDs (A, B, C, D), scratch analysis results for each zone, and defect analysis results for each zone.

Specifications ^a

OPTICAL PERFORMANCE	
Field of View (viewed on FOCIS Flex)	Live: 710 x 860 μm; Captured, Zoomed Out: 560 x 600 μm; Captured, Partially Zoomed In: 360 x 390 μm; Captured, Fully Zoomed In: 180 x 195 μm
Field of View (Viewed on a PC)	Stored, Zoomed Out: 700 x 525 μm; Stored, Fully Zoomed In: 240 x 180 μm
Manual Detection Capability (minimum)	0.25 μm
Auto Analysis Resolution	<1.0 μm
Captured Image Size (Pixels)	648 x 480 VGA; Images stored internally in three .JPG files, one at each FOV
OPERATING FEATURES	
Focus	Auto-focus and manual focus
Centering	Auto-centering after capture
Pass/Fail Analysis	IEC 61300-3-35 (2015), IPC and user-defined criteria
Image Capture and File Storage Capacity	10,000 files
File Format (Image and Pass/Fail Results)	jpg, gif
Bluetooth Characteristics	SPP to FlexScan and FlexTester OTDRs; IAP to iOS devices
USB Characteristics	USB 1.1 mass storage device
Supported Languages	English, Chinese Simplified, Chinese Traditional, Finnish, French, German, Italian, Japanese, Korean, Polish, Russian, Spanish, Turkish
PHYSICAL AND POWER CHARACTERISTICS	
Display size, type, resolution	2.4", TFT, 240 x 320 with brightness control
Battery Type	NiMH, user replaceable
Battery Operating Time (typical)	8 hours (60 tests in 20 minutes each hour; auto-off enabled)
Recharge Time	<4.5 hours
Power Save Features	Auto-off (disabled, 2, 5, 10 minutes)
AC Charger voltage, frequency, current	100-240 V, 50/60 Hz, 5VDC, 2A
Size	47 x 37 x 183 mm (1.8 x 1.5 x 7.2 in)
Weight	240 g (0.5 lb)
ENVIRONMENTAL CHARACTERISTICS	
Operating Temperature	0 to +50 °C
Storage Temperature	-40 to +70 °C
Relative Humidity	95%, non-condensing
Transit and shock	2G vibration, 30G shock

Notes:

a. All specifications valid at 23°C ±2°C (73.4°F ±3.6°F).

FOCIS Flex – Fiber Optic Connector Inspection System

Easy, Fast, Compact, Tether-free

U.S. Patent 9,217,688

FlexScan OTDR PRO and BIPM Kits with FOCIS Flex

PRO Kits include the following items:

- FlexScan with accessories (AC charger, carry strap, SC/2.5 mm connector adapters, TRM® 3.0 Advanced Test Results Manager, carry case)
- FOCIS Flex Fiber Optic Connector Inspection System with accessories (AC charger, USB cable, soft carry case/holster)
- Two user-selected adapter tips and one user-selected One-Click Cleaner
- 150 m Fiber Ring (launch cable) with user-specified connectors

Complete kits expand on PRO Kits by adding bend insensitive fiber identifier with optional power meter (OFI-BIPM).

See FlexScan data sheet for FlexScan PRO and Complete Kit ordering information.

FOCIS Flex Adapter Tips (Contact AFL for adapter tips for other connector types)

DESCRIPTION	AFL NO.
SC-UPC bulkhead adapter tip	FFLX-01-SC
FC-UPC bulkhead adapter tip	FFLX-01-FC
ST-UPC bulkhead adapter tip	FFLX-01-ST
LC-UPC bulkhead adapter tip	FFLX-01-LC
Universal 2.5 mm, UPC ferrule adapter tip	FFLX-01-U25
Universal 1.25 mm, UPC ferrule adapter tip	FFLX-01-U125
SC-APC bulkhead adapter tip	FFLX-4S-ASC
FC-APC bulkhead adapter tip	FFLX-4S-AFC
LC-APC bulkhead adapter tip	FFLX-4S-ALC
Universal 2.5 mm, APC ferrule adapter tip	FFLX-01-A25
Universal 1.25 mm, APC ferrule adapter tip	FFLX-01-A125
FOCIS Flex adapter extension tube, straight, 46 mm	FFLX-01-EXTS46
FOCIS Flex adapter extension tube, straight, 80 mm:	FFLX-01-EXTS80
E2000 PC/UPC bulkhead adapter tip	FFLX-4S-E2K
E2000 APC bulkhead adapter tip	FFLX-4S-E2KA
Tip for SC/APC (OptiTap®) bulkhead adapter	FFLX-4S-OTA
Tip for OptiTip® APC ferrule and bulkhead adapter	DFS1-01-0013MR
MTP/PC ferrule & bulkhead adapter extended tip kit (base plus MTP/PC front end tip)	DFS1-00-0037MR
MTP/PC and MTP/APC ferrule & bulkhead adapter extended tip kit (base, MTP/PC, MTP/APC front end tips)	DFS1-00-0042MR
MTP/APC ferrule and bulkhead adapter extended tip kit (base plus MTP/APC front end tip)	DFS1-01-0010MR

Ordering Information

DESCRIPTION	AFL NO.
FOCIS Flex Kit, soft carry case/holster, USB cable, AC charger, TRM® 3.0 reporting software, reference guide, no tips	FOCIS-FLX-P4XN
FOCIS Flex Kit, soft carry case/holster, USB cable, AC charger, TRM 3.0 reporting software, reference guide, 2 user-selected UPC adapter tips (ferrule and bulkhead), user-selected One-Click cleaner	FOCIS-FLX-P4XU
FOCIS Flex Kit, soft carry case/holster, USB cable, AC charger, TRM 3.0 reporting software, reference guide, 2 user-selected APC adapter tips (ferrule and bulkhead), user-selected One-Click cleaner	FOCIS-FLX-P4XA
FOCIS Flex Kit, soft carry case/holster, USB cable, AC charger, TRM 3.0 reporting software, reference guide, user-selected UPC adapter tips (ferrule and bulkhead), 2 user-selected APC adapter tips (ferrule and bulkhead), user-selected One-Click cleaner	FOCIS-FLX-P4XUA

FOCIS Flex – Fiber Optic Connector Inspection System

Easy, Fast, Compact, Tether-free

U.S. Patent 9,217,688

Test Management and Reporting Software

DESCRIPTION	AFL NO.
TRM 3.0 with Basic License, USB delivery (included with all FOCIS Flex kits)	TRM3-BASIC
TRM 3.0 upgrade from Basic to Advanced License, USB delivery	TRM3-UPGRADE
TRM 3.0 upgrade from Basic to Advanced License, email delivery	TRM3-UP-EMAIL
FOCIS Flex App (Google play or App Store)	Free Download

Recommended Products



FlexScan® FS300 (quad) and FS200 (single-mode) OTDRs

- SmartAuto® 1-button automated testing for fast results
- LinkMap® color-coded icons for easy troubleshooting
- FleXpress® mode (FS200) completes OTDR test in <5 seconds!
- Integrated Source, Power Meter and VFL



OFI-BIPM Optical Fiber Identifier

- World class signal sensitivity
- Trigger lock, positive stop for optimum detection
- Integrated optical power meter option

Qualifications

CATEGORY	REGULATION/STANDARD	QUALIFICATION
CE Marking	EU	Compliant to relevant EU Directives on health, safety, and environmental protection, and certified with CE marking
Safety /EMC /EMI	IEC	Compliant to IEC 61010-1 for safety requirements for electrical equipment
	EN	Compliant to EN 61010-1 for safety requirements for electrical equipment
	IEC	Compliant to IEC 61326-1 for EMC requirements for electrical equipment
	EN	Compliant to EN 61326-1 for EMC requirements for electrical equipment
	EN	Compliant to EN 55011 for EMC requirements for industrial, scientific and medical equipment
	FCC	Compliant to code of federal regulations FCC 47 CFR 15 on unlicensed transmissions
	FDA	Compliant to code of federal regulations FDA 21 CFR 1040.10 and 1040.11 on laser products
RoHS	IEC	Compliant to IEC 60825-1 for safety of laser products
	EU	Compliant to EU regulations Directive 2011/65/EU (RoHS 2) and Directive 2015/863 (RoHS 3)
Test Method	IEC	Compliant to IEC 61300-3-35 for visual inspection of fiber optic connectors and fiber-stub transceivers
	IPC	Compliant to IPC-8497-1 for cleaning methods and contamination assessment for optical assembly

Contact Sales@AFLglobal.com to schedule a demonstration or learn how to buy.

Visit www.AFLglobal.com/Test to learn more about FOCIS Flex.

International Sales and Service Contact Information available at www.AFLglobal.com/Test/Contacts.

Optical Loss Test Kits

5 YEAR WARRANTY



SMLP5-5 Kit

Features

- Rugged, dependable, and backed by industry-best 5-year warranty
- Wave ID tests up to three wavelengths simultaneously - slashing test time
- Field-swappable connector adapters for maximum flexibility
- Long battery life from globally available AA batteries

Applications

- Certify multimode and single-mode links per TIA/EIA standards
- Passive Optical Networks (PON) testing
- Certification report generation with TRM® 2.0 software
- Fiber identification for splicing and continuity checking

Optical Loss Test Sets (OLTS) provide the most accurate method for determining the total loss of a link. AFL's OLTS have been an industry favorite for over 30 years with more than 100,000 units shipped. Leading service providers and enterprise customers rely on AFL's OLTS for their ruggedness, reliability, and best-in-the-industry 5-year warranty.

An OLTS test is performed with a light source on one end of the fiber sending a continuous wave at specific wavelength(s) and a power meter on the opposite end measuring the light received. The loss measured is compared to the loss budget, which is usually calculated prior to installation, and reflects the industry standards used to ensure that the link can meet its application requirements.

OLTS are mainly used to certify multimode and single-mode links, test Passive Optical Networks (PONs), identify fibers before splicing, and to ensure network continuity.

Designed for use in outside plant environments: AFL OLTS are extremely rugged and withstand one-meter drops, have splash resistant controls that are easy to use with gloves on, and the field-swappable connector adapters provide flexibility and access for cleaning optical ports at time of test.

Test faster with fewer errors: AFL's Wave ID increases test speed by performing simultaneous multi-wavelength testing that cuts loss measurement time in half or more. AFL's automatic wavelength identification eliminates setup errors and simplifies coordination between users at opposite ends of fiber.

Optical Loss Test Kits

Specifications^a

OPTICAL SPECIFICATIONS - POWER METERS			
MODEL	OPM5-4D	OPM5-3D, OPM4-3D	OPM5-2D
Calibrated Wavelengths	850, 980, 1300, 1310, 1490, 1550, 1625 nm	850, 1300, 1310, 1490, 1550, 1625 nm	850, 1300, 1310, 1490, 1550 nm
Detector Type	Filtered InGaAs	InGaAs	Germanium (Ge)
Measurement Range	+26 to -50 dBm	+10 to -75 dBm	+6 to -60 dBm
Tone Detect Range	+6 to -30 dBm +6 to -25 dBm for 850 nm	+10 to -50 dBm +10 to -45 dBm for 850 nm	+6 to -50 dBm +6 to -45 dBm for 850 nm
Wavelength ID Range	+6 to -30 dBm +6 to -25 dBm for 850 nm	+10 to -50 dBm +10 to -45 dBm for 850 nm	+6 to -50 dBm +6 to -45 dBm for 850 nm
Accuracy	±0.1 dB (typical); ±0.25 dB		
Resolution	0.01 dB		
Measurement Units	dB, dBm, μW		

OPTICAL SPECIFICATIONS: OLS7 MODELS			
MODEL	OLS7-FTTH (Single Port)		
Wavelength (±20 nm)	1310 nm	1490 nm	1550 nm
Spectral Width	5 nm	3 nm	5 nm
Emitter Type	Laser		
Safety Class	Class I FDA 21 CFR 1040.10 and 1040.11, IEC 60825-1: 2007-03		
Output Power	-5 dBm (typical), 9/125 fiber		
Output Stability	±0.05 dB over 1 hour (after 15 minutes warm-up) ±0.1 dB over 8 hours (after 15 minutes warm-up)		
Tone Output	270 Hz, 330 Hz, 1 kHz, 2 kHz		

OPTICAL SPECIFICATIONS: OLS4, OLS2-DUAL & OLS1-DUAL MODELS						
MODEL	OLS4 (MM Optical Port)		OLS4 (SM Optical Port)		OLS2-DUAL (Single Port)	
Wavelength	850 ±30 nm	1300 +30/-20 nm	1310 ±20 nm	1550 ±20 nm	1310 ±20 nm	1550 ±20 nm
Spectral Width	45 nm (typ)	120 nm (typ)	5 nm (max)	5 nm (max)	5 nm (max)	
Emitter Type	LED		Laser		Laser	
Safety Class	Class I FDA 21 CFR 1040.10 and 1040.11, IEC 60825-1: 2007-03					
Output Power	>-20 dBm, 62.5 μm multimode ^b		0 dBm, 9 μm single-mode		0 dBm, 9 μm single-mode ^c	
Output Stability	±0.1 dB over 8 hours (after 5 minutes warm-up)		±0.05 dB over 1 hour (after 15 minutes warm-up) ±0.1 dB over 8 hours (after 15 minutes warm-up)			
Tone Output	N/A		2 kHz		270 Hz, 330 Hz, 1 kHz, 2 kHz	

GENERAL SPECIFICATIONS: ALL OPM AND OLS MODELS	
Available Adapters	SC FC, ST, LC
Power	2 AA batteries
Operating Temperature	-10 °C to 50 °C, 90 % RH (non-condensing)
Storage Temperature	-30 °C to 60 °C, 90 % RH (non-condensing)
Size (H x W x D)	14.0 x 8.1 x 3.8 cm (5.5 x 3.2 x 1.5 in)
Weight	0.29 kg (0.65 lb)

Notes:

- All specifications valid at 25°C unless otherwise specified.
- May be used to test 50 or 62.5 μm fiber with supplied mandrels.
- Output power will be approximately 3 dB less if a 50 μm mandrel-wrapped jumper is used instead of a 62.5 μm mandrel-wrapped jumper.
- Adjustable 2 dB.

Optical Loss Test Kits

Ordering Information

Test kits include light source, power meter, protective rubber boots, AA batteries, adapter caps, and carry case.

AFL NO.	POWER METER	LIGHT SOURCE	FIBER TYPE	LOSS MEASUREMENTS (nm)					DYNAMIC RANGE (dB)	TRM® 2.0 PC REPORTING
				850	1300	1310	1490	1550		
SLP5-6	OPM5-3D	OLS2-DUAL	SM			◆		◆	70 ^b	◆
SLP5-FTTH	OPM5-4D	OLS7-FTTH	SM			◆	◆	◆	45 ^b	◆
SMLP5-5	OPM5-2D	OLS4	MM SM	◆	◆	◆		◆	40 @ 850/1300 nm ^a 60 @ 1310/1550 nm ^b	◆

Notes:

- a. On 62.5/125 µm multimode fiber.
- b. On 9/125 µm single-mode fiber.

Part Number – Connector Specification

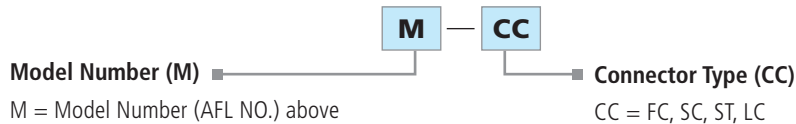

Examples: SMLP5-5-SC => (SMLP5-5 Test Kit with SC adapters)

Accessories

DESCRIPTION	AFL NO.
LIGHT SOURCE CONNECTOR ADAPTERS	
FC connector adapter	2900-50-0002MR
SC connector adapter	2900-50-0003MR
ST connector adapter	2900-50-0004MR
LC connector adapter	2900-50-0006MR
POWER METER CONNECTOR ADAPTERS	
FC connector adapter	8800-00-0200
SC connector adapter	8800-00-0209
ST connector adapter	8800-00-0202
LC connector adapter	8800-00-0225
MULTIMODE TEST CORDS (50/125 µm – 2 meters)	
FC/FC	8700-00-0093
SC/ST	8700-00-0064
SC/SC	8700-00-0065
LC/LC	8700-00-0082
SINGLE-MODE TEST CORDS (9/125 µm – 2 meters)	
FC/FC	8700-00-0005
FC/ST	8700-00-0016
ST/ST	8700-00-0017
SC/SC	8700-00-0018
FC/SC	8700-00-0021
SC/ST	8700-00-0022
SC/LC	8700-00-0046
FC/LC	8700-00-0071
LC/LC	8700-00-0097

DESCRIPTION	AFL NO.
MATING ADAPTERS (Bulkheads)	
FC/FC	8400-00-0004MR
SC/SC	8400-00-0045MR
ST/ST	8400-00-0020
LC/LC	8400-00-0075
CLEANING SUPPLIES	
One-Click Cleaner SC/ST/FC	8500-05-0001MZ
One-Click Cleaner LC	8500-05-0002MZ
Cletop –SB Cassette Cleaner	8500-10-0016MZ
Cletop –SB Refill Cartridge	8500-10-00017MZ

Optical Loss Test Kits

Test Management and Reporting Software

DESCRIPTION	AFL NO.
TRM® 2.0 with Basic License (OTDR Trace/OLTS Viewer, Batch Editor and Reports), USB delivery	TRM-00-0900PR

Recommended Products



OFI-BIPM Optical Fiber Identifier

- World class signal sensitivity
- Trigger lock, positive stop for optimum detection
- Integrated optical power meter option



One-Click® Cleaners

- Patented single-action
- Variety of sizes and types
- Low cost per clean

Qualifications

CATEGORY	REGULATION/STANDARD	QUALIFICATION
CE Marking	EU	Compliant to relevant EU Directives on health, safety, and environmental protection, and certified with CE marking
Safety/EMC/EMI	IEC	Compliant to IEC 61010-1 for safety requirements for electrical equipment
	EN	Compliant to EN 61010-1 for safety requirements for electrical equipment
	IEC	Compliant to IEC 61326-1 for EMC requirements for electrical equipment
	EN	Compliant to EN 61326-1 for EMC requirements for electrical equipment
	EN	Compliant to EN 55011 for EMC requirements for industrial, scientific and medical equipment
	FDA	Compliant to code of federal regulations FDA 21 CFR 1040.10 and 1040.11 on laser products
RoHS	IEC	Compliant to IEC 60825-1 for safety of laser products
	EU	Compliant to EU regulations Directive 2011/65/EU (RoHS 2) and Directive 2015/863 (RoHS 3)
Test Method	TIA	Compliant to TIA-568.3-D for test and measurement requirements for premises optical fiber cabling and components*
	IEC	Compliant to IEC 11801 for test and measurement requirements for optical fiber cabling for use within premises*
	EN	Compliant to EN 50173 for test and measurement requirements for optical fiber cabling for use within premises*
	AS/NZS	Compliant to AS/NZS 3080 for test and measurement requirements for optical fiber cabling for use within premises*
	TIA	Compliant to TIA-526-7 for test procedures for installed optical fiber cable plant
	TIA	Compliant to TIA-526-14 for test procedures for installed optical fiber cable plant*
	IEC	Compliant to IEC 14763-3 for systems and methods for the inspection and testing of installed optical fiber cabling*
	AS/NZS	Compliant to AS/NZS 14763.3 for systems and methods for the inspection and testing of installed optical fiber cabling*
	IEC	Compliant to IEC 61280-4-1 for test procedures for installed optical fiber cable plant*
	IEC	Compliant to IEC 61280-4-2 for test procedures for installed optical fiber cable plant
Generic Requirement	IEC	Compliant to IEC 61315 for requirements on calibration of fibre-optic power meters

* A complementary encircled flux mode conditioner may be needed to comply with encircled flux launch conditions for testing multimode optical fiber cabling and components

Contact Sales@AFLglobal.com to schedule a demonstration or learn how to buy.

Visit www.AFLglobal.com/Test to learn more about OLTS kits.

International Sales and Service Contact Information available at www.AFLglobal.com/Test/Contacts

VFI4 Visual Fault Identifiers

Fiber Identification



VFI4 High Power Model

VFI4-L Low Power Model

Features

- Eye-safe Class 3R visible red laser source, 650 nm (High power version)
- Output power of 5.0 mW with 10 km range (High power version)
- Universal connector interface for quick connection
- 2.5 mm universal adapter (included) accepts FC, SC, ST, etc. connectors
- 1.25 mm universal adapter (included in High power version only) accepts LC and MU connectors
- Low power model - VFI4-L is available with output power of 1.0 mW with 4 km range

Applications

- Identify and trace fibers during activation and installation
- Identify poorly mated connectors
- Verify AFL's FASTConnect® field-installable connector installation
- Find faults inside OTDR dead zones

A Visible Fault Identifier (VFI), also referred to as a Visual Fault Locator (VFL), is an essential tool for fiber installation and maintenance technicians.

AFL's compact VFI4 injects high-powered red-laser light to provide exceptional brightness and range for locating defects in single-mode and multimode fibers. The light generated by these units will escape from sharp bends and breaks in jacketed or bare fibers, as well as poorly mated connectors enabling technicians to quickly spot faults. The universal connector interface mates with many connector styles without needing an adapter.

Rugged and Compact: The rugged VFI4 is designed for the rigors of real-life field testing. It has a range of up to 10 km, fits on a keychain, and features extensions that protect the red-laser port. It has both CW and pulsating modes and is powered by a single AA battery for up to 30 hours of operation.

Installation and Activation: VFI4 is used for quick continuity checks, fiber tracing, splice verification, and Pass/Fail validation for mechanical connectors. VFI4 is also an excellent complement to any OTDR because it can locate faults inside the OTDR's dead zone.

Essential Troubleshooting Tool: The VFI4 highlights sharp bends, breaks, faulty connectors, and other defects that "leak" light. Other applications include end-to-end continuity checks, as well as identifying connectors in patch panels and fibers during splicing operations.

VFI4 Visual Fault Identifiers

Specifications^a

OPTICAL	VFI4	VFI4-L
Emitter Type	Laser, Class IIIa FDA 21 CFR 1040.10 and 1040.11, Class 3R IEC 60825-1:2014	Laser, Class II FDA 21 CFR 1040.10 and 1040.11, Class 2 IEC 60825-1:2014
Wavelength	650 nm ± 15 nm	
Output Power	5 mW maximum	1 mW maximum
Modulation	2 Hz or CW selected	

Notes:

a. All specifications valid at 25°C unless otherwise specified.

GENERAL	VFI4	VFI4-L
Adapter	2.5 mm Universal, 1.25 mm Universal	
Power	1 AA battery, <30 hours (flash mode)	1 AA battery, <50 hours (flash mode)
Operating Temperature	-10°C to 50°C, 85 % humidity non condensing	
Storage Temperature	-30°C to 60°C, 95 % humidity non condensing	
Size (H x W x D)	7.9 x 5.1 x 2.2 cm (3.1 x 2.0 x 0.9 in)	
Weight	43 g (1.5 oz)	

Ordering Information

DESCRIPTION	AFL NO.
VFI4 visual fault identifier with 2.5 mm and 1.25 mm adapters	VFI4-01-0900PR
VFI4-L visual fault identifier with 2.5 mm adapter	VFI4-02-0900PR

Adapters

DESCRIPTION	AFL NO.
2.5 mm Universal for VFI port	2900-50-0013MR
1.25 mm Universal for VFI port	2900-50-0012MR

Recommended Products



One-Click® Cleaner Mini

- Small compact design with single action cleaning
- Automatically advance ensures each clean is performed with fresh cleaning tape
- 100 clean and 500 clean versions available
- Low cost per clean



FASTConnect® Field-Installable Connectors

- Field-installable, takes less than a minute to complete
- Fast and easy to terminate
- Low insertion/return loss
- Reusable

Qualifications

CATEGORY	REGULATION/STANDARD	QUALIFICATION
CE Marking	EU	Compliant to relevant EU Directives on health, safety, and environmental protection, and certified with CE marking
Safety/EMC/EMI	IEC	Compliant to IEC 61010-1 for safety requirements for electrical equipment
	EN	Compliant to EN 61010-1 for safety requirements for electrical equipment
	IEC	Compliant to IEC 61326-1 for EMC requirements for electrical equipment
	EN	Compliant to EN 61326-1 for EMC requirements for electrical equipment
	EN	Compliant to EN 55011 for EMC requirements for industrial, scientific and medical equipment
	FDA	Compliant to code of federal regulations FDA 21 CFR 1040.10 and 1040.11 on laser products
	IEC	Compliant to IEC 60825-1 for safety of laser products
RoHS	EU	Compliant to EU regulations Directive 2011/65/EU (RoHS 2) and Directive 2015/863 (RoHS 3)

Contact Sales@AFLglobal.com to schedule a demonstration or learn how to buy.

Visit www.AFLglobal.com/Test to learn more about VFI4 Visual Fault Identifier.

International Sales and Service Contact Information available at www.AFLglobal.com/Test/Contacts.



 Bluetooth®

90S+



In Work Tray



Wind Protector Open

Fujikura 90S+ Fusion Splicer

The Fujikura 90S+ core alignment fusion splicer solves common problems seen in the field—from splicing poor quality legacy fiber to automated equipment maintenance and upkeep. The Fujikura 90S+ can be use in multiple field splicing applications including bend-insensitive fibers in drop cables, long-haul terrestrial and submarine LEAF® fibers, loose buffer fiber, splice-on connectors, and the list goes on. The speed and accuracy of the 90S+ make it suitable for certain production and specialty environments where high output, tight packaging, and low loss requirements are required.

Regardless of your scenario, the Fujikura 90S+ is designed to keep you in the field with an extended battery life of 300 splice and heat cycles. With its multiple automated and easy-to-use features, the 90S+ alleviates the need for traditional operation tasks such as frequent arc calibrations, cleaver blade rotations, cleaver usage tracking, and manual splicing operations. A redesigned work tray, cooling tray, and optional cable clamp make the 90S+ kit more versatile than its predecessors in adapting to varying work conditions and environments.

When splicing loose buffer fiber, additional sheath clamps are not needed. The standard universal sheath clamp now handles both loose and tight buffer fibers. The new Active Fusion Control (AFC) technology improves splice losses for fibers that possess a poor cleave angle. Combined with Active Blade Management between the splicer and cleaver, the Fujikura 90S+ contains a robust set of splicing features that will reduce the likelihood of poor splice installations or repairs.

Features

- Cleaver tracking and upkeep with wireless communication
- Improved real-time arc control for fibers with poor cleave angles
- Automated wind protector, sheath clamps and splice operation
- Loose and tight buffer with same sheath clamp
- Lithium-ion battery with 300 splices/shrinks per charge
- PC software and 90S+ manual downloaded from splicer
- Multi-function transit case with integrated workstation

Applications

- Distribution fiber repair
- Long-haul network installation
- Field termination with splice-on connectors
- Access network installation
- Fanout kits, pigtailed and splice cassettes
- OSP cable installation and repair
- Optical modules – splitters, couplers, MUXs, EDFAs and attenuators

STOCK ITEM

Fujikura 90S+ Fusion Splicer

Ordering Information

DESCRIPTION	AFL NO.
90S+ Fusion Splicer (machine only) Includes: ADC-20 AC Adapter, ACC-14 AC Cord, BTR-15 Battery, ELCT2-16B Spare Electrodes (pair), Sheath Clamps, SP-03 Fiber Holder Set Plates, USB-01 Cable, Alcohol Dispenser, Screwdriver, Splicer Carrying Strap, Quick Reference Guide, TS-03 Tripod Screw, Work Tray J-Plate, SS03 single fiber stripper, CC39 Transit Case with Carrying Strap and Two Year Warranty	S017519
90S+ Fusion Splicer Kit (with cleaver) Includes: CT50 Cleaver, ADC-20 AC Adapter, ACC-14 AC Cord, BTR-15 Battery, ELCT2-16B Spare Electrodes (pair), Sheath Clamps, SP-03 Fiber Holder Set Plates, USB-01 Cable, Alcohol Dispenser, Screwdriver, Splicer Carrying Strap, Quick Reference Guide, TS-03 Tripod Screw, Work Tray J-Plate, SS03 single fiber stripper, CC39 Transit Case with Carrying Strap and Two Year Warranty	S017521
90S+ Fusion Splicer without Bluetooth (machine only) Includes: ADC-20 AC Adapter, BTR-15 Battery, ACC-14 AC Cord, ELCT2-16B Spare Electrodes (pair), Sheath Clamps, SP-03 Fiber Holder Set Plates, USB-01 Cable, Alcohol Dispenser, Screwdriver, Splicer Carrying Strap, Quick Reference Guide, TS-03 Tripod Screw, Work Tray J-Plate, SS03 Single Fiber Stripper, CC39 Transit Case with Carrying Strap and Two Year Warranty	S017520
One Year Extended Warranty	S012996
Two Year Extended Warranty	S013000

Recommended Products for the 90S+

DESCRIPTION	AFL NO.
Cleavers	
CT-16 Cleaver	S018330
CT-50 Cleaver	S017030
Fiber Holders (pair)	
FH-70-250 (250 μm coated fiber)	S017111
FH-70-900 (900 μm jacketed fiber)	S017113
FH-70-160 (160 μm coated fiber)	S017095
FH-70-200 (200 μm coated fiber)	S017711
FH-60-LT900 (Loose buffer 900 μm fiber)	S015181
FUSEConnect® Accessories	
FH-FC-20 (900 μm within 2.0 mm sheathing) (each)	S014696
FH-FC-30 (900 μm within 3.0 mm sheathing) (pair)	S014695
FH-FC-900 (900 μm cable) (each)	S014697
CLAMP-FC-2000 (pair)	S014705
CLAMP-FC-3000 (single holder)	S014704
Power Supply Options and Equipment	
ADC-20 AC Adapter	S017513
ACC-14 AC Power Cord	S014536
BTR-15 Battery	S017512
DCC-20 Power Cord (connects AC Adapter to cigarette lighter socket)	S017527
DCC-21 Power Cord (connects AC Adapter to power source via alligator clips)	S017528

DESCRIPTION	AFL NO.
Miscellaneous	
SS03 Single fiber stripper (3 hole)	S017098
SS01 Single fiber stripper (1 hole)	S017099
ELCT2-16B Electrodes	S017103
SP-03 Fiber Holder Set Plates	S017518
S90 Universal Sheath Clamps	S017696
Portable Tripod Workstation (see product profile for more detail)	S014773
ASW-02 Splicing Workstation (see product profile for more detail)	S010532
WT-09R Work Tray Right	S017515
WT-09L Work Tray Left	S017516
JP-09 Work Tray J-Plate	S017517
JP-10 J-Plate (Cooling tray attaches to splicer)	S017522
JP-10-FC J-Plate with Fiber Clamps	S017523
TS-03 Tripod Screw (90 Series)	S017524
ST-02 Fusion Splicer Strap	S017525
CLAMP-DC-12 (Drop cable clamp for work tray)	S017550
USB-01 Cable	S014777
CC39 Transit Case	S017514
Splicer V-Groove Cleaning Kit	S014397
ST-03 Case and Work Tray Strap	S017549



Fiber Holders

- Wide range of sizes for various applications
- Loose & Tight Buffer options available



Portable Tripod Work Station

- Sturdy work tray supports the splicer, cleaver and accessories
- Tripod supports a load capacity of up to eleven pounds



V-Groove Cleaning Kit

- Removes environmental contamination from the v-groove of the splicer
- Maintains performance and ensures fiber alignment

Fujikura 90S+ Fusion Splicer

Specifications

PARAMETER		VALUE
Fiber Alignment Method		Active core alignment
Fiber Count Can Be Spliced		Single fiber
Applicable Fiber	Fiber Type	Single-mode optical fiber
	Cladding Diameter	Multimode optical fiber 80 to 150 μm
Applicable Coating	Sheath Clamp	Coating dia.: Max. 3,000 μm Cleave length: 5 to 16 mm
	Splice Loss	ITU-T G.652: Avg. 0.02 dB ITU-T G.651: Avg. 0.01 dB ITU-T G.653: Avg. 0.04 dB ITU-T G.654: Avg. 0.04 dB ITU-T G.655: Avg. 0.04 dB ITU-T G.657: Avg. 0.02 dB
Fiber Splice Performance	Splice Time	SM FAST mode: Avg. 8 to 10 sec. SMAUTO mode: Avg. 11 to 13 sec. AUTO mode: Avg. 14 to 16 sec.
	Sleeve Type	Heat-shrinkable sleeve
Applicable Protection Sleeve	Sleeve Length	Max. 66 mm
	Sleeve Dia.	Max. 6.0 mm before shrinking
Sleeve Heat Performance	Heat Time	60 mm slim mode: Avg. 9 to 10 sec. 60 mm mode: Avg. 13 to 15 sec.
Fiber Tensile Test Force		Approx. 2.0 N
Electrode Life		Approx. 5,000 splices
Physical Description	Dimensions W	Approx. 170 mm without projection
	Dimensions D	Approx. 173 mm without projection
	Dimensions H	Approx. 150 mm without projection
	Weight	Approx. 2.8 kg including battery
Environmental Condition	Temperature	Operate: -10 to 50°C Storage: -40 to 80°C
	Humidity	Operate: 0 to 95% RH non-condensing Storage: 0 to 95% RH non-condensing
	Altitude	Max. 5,000 m
AC Adaptor	Input	AC100 to 240 V, 50/60 Hz, Max. 1.5 A
Battery Pack	Type	Rechargeable Lithium Ion
	Output	Approx. DC14.4V / 6,380 mAh
	Capacity	Approx. 300 splice and heat cycles
	Temperature	Recharge: 0 to 30°C Storage: -20 to 30°C
	Battery Life	Approx. 500 recharge cycles
Display	Recharge Time	Approx. 5-8 hours from empty
	LCD Monitor	TFT 5 inches with touch screen
Illumination	Magnification	200 to 320x
	V-Grooves	LED lamp
Interface	PC	USB2.0 Mini B type
	External Led Lamp	USB2.0 A type, Approx. DC5V, 500 mA
	Ribbon Stripper	Mini DIN 6 pin, DC12V, Max. 1A
	Wireless	Bluetooth 4.1 LE
Data Storage	Splice Mode	100 splice modes
	Heat Mode	30 heat modes
	Splice Result	20,000 splices
	Splice Image	100 images
Screw Hole For Tripod		1/4-20 UNC
Other Features	Automatic Functions	Splice mode select by fiber type analysis
		Discharge power calibration
		Wind protector: open/close
		Sheath clamp: open
		Heater lid: open/close
Reference Guide	Sheath Clamp	Heater clamp: open/close
		Video and PDF file stored in splicer
		Easy sleeve positioning clamp
Electrode		Replaceable without tool



45S

Fujikura 45S Fusion Splicer

The 45S cladding alignment fusion splicer is changing the way people splice fiber in small to mid-fiber count applications. This Fujikura splicer debuts a landmark improvement to the fusion splicing process with the ability to prepare and load both fibers simultaneously. The hand-held fiber coating stripper, the SS-05, is capable of stripping two 250 μ m coated fibers in the same pass, along with the CT-16A cleaver adapter plate which can likewise accommodate two bare fibers for cleaving. After preparation, the 45S patented sheath clamps enable loading both fibers simultaneously into the splicer with one fiber in each hand. The user can press down on the sheath clamp base to close it while positioning the fiber in the v-grooves. This enables one-handed operation.

Furthermore, the 45S sheath clamps are mechanically linked to the wind protector, so after splicing is finished, opening the wind protector also opens both sheath clamps for quick sleeve positioning and transfer to the tube heater. The 45S tube heater shrinks sleeves much faster than its predecessor with a nominal ~20 second heat time for 60 mm sleeves down from ~26 seconds. The simultaneous fiber preparation capability, automated sheath clamp opening, and a faster tube heater, combine to lower the overall fusion splicing cycle time by ~30% or more.

The 45S continues to benefit the user experience with improvements to fiber placement, battery access, and machine ergonomics. Previously, when using sheath clamps, if the cleaved fiber was accidentally set past the electrode centerline, the machine would send an error and require manual intervention. The 45S will now accept this mistake and reverse the fiber to correct position automatically. With a cube form factor, the 45S is easily transported and operated in space-constrained environments. The adjustable screen can alleviate glare from the sun and adjust with abnormal splicer positions confronted in challenging splice locations.

Backed by the best service team in the industry, the Fujikura 45S is the ideal splicer to use when portability, ruggedness, speed, and reliability are needed. If you'd like to see the 45S capabilities first-hand, please contact us at 1-800-235-3423 to arrange a product demonstration at your earliest convenience.

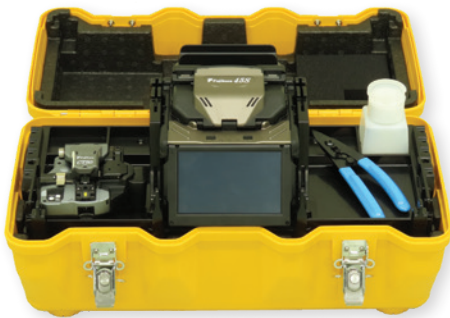

45S Standard Kit

Applications

- 5G Small Cell Site
- FTTx drops and terminations
- MDF/IDF splices and terminations
- Rural fiber deployments and restorations

Features

- Simultaneous fiber preparation with newly patented sheath clamp design
- Sheath clamps automatically opened with the wind protector
- Automatic fiber placement correction
- Active Fusion Control for arc optimization with every splice
- Active Blade Management for cleave quality monitoring and correction
- Easy-access battery, screen position adjustments, and ergonomic adaptations
- Fully ruggedized for shock, moisture and dust resistance



45S on Tripod

Fujikura 45S Fusion Splicer

Features

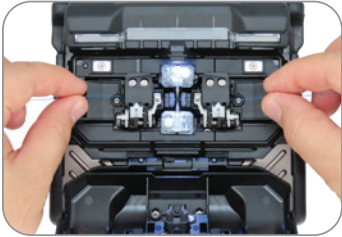

Simultaneous Fiber Loading

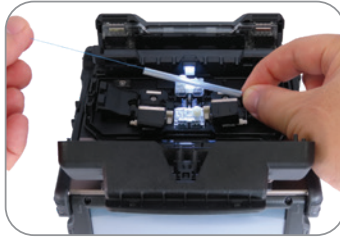

Sleeve Positioning

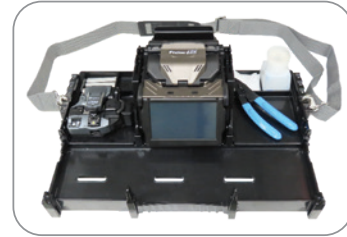

Work Tray with Neck Strap

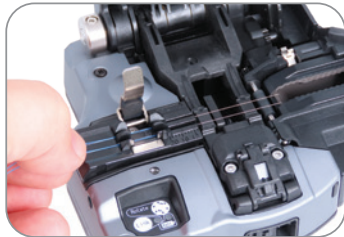

CT-16A Adapter Plate on CT-50

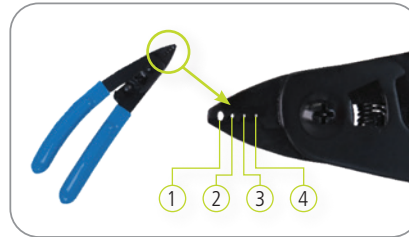

Fiber stripper SS-05

- ① For 2.3 mm
- ② For 900 μ m
- ③ For 250 μ m
- ④ For 250 μ m

Single Fiber Splicers

Ordering Information

DESCRIPTION	AFL NO.
Fujikura 45S Standard Kit Includes: CT-50 cleaver, SS-05 single fiber stripper, 1 pair each FH-70-250 and FH-70-900 fiber holders, SP-04 set plates, ELCT2-16B Spare Electrodes (Pair), ADC-21 AC Adapter, BTR-17 Battery Pack (installed), ACC-09 Power Cord, USB-01 USB Cable, AP-02 Alcohol Container, WT-10 work tray, ST-03 carrying case strap, TS-03 tripod screw, CC-45 Transit Case, 1 year factory warranty, and instruction manual downloaded from splicer	S018318
Fujikura 45S Kit without Cleaver Includes: SS-05 single fiber stripper, 1 pair each FH-70-250 and FH-70-900 fiber holders, SP-04 set plates, ELCT2-16B Spare Electrodes (Pair), ADC-21 AC Adapter, BTR-17 Battery Pack (installed), ACC-09 Power Cord, USB-01 USB Cable, AP-02 Alcohol Container, WT-10 work tray, ST-03 carrying case strap, TS-03 tripod screw, CC-45 Transit Case, 1 year factory warranty, and instruction manual downloaded from splicer	S018319
One Year Extended Warranty	S012996
Two Year Extended Warranty	S013000

Recommended Accessories

DESCRIPTION	AFL NO.
Cleavers AND STRIPPERS	
CT-50 Fiber Cleaver	S017030
CT-16 Fiber Cleaver	S018330
SS-05 Dual Fiber Stripper	S018327
Fiber Holders	
CLAMP-S35B Loose Buffer Sheath Clamp	S018333
FH-70-250 (250 μ m single fiber)	S017111
FH-70-200 (200 μ m single fiber)	S017711
FH-70-900 Fiber Holders (900 μ m single fiber)	S017113
FH-60-LT900 (900 μ m loose buffer tube)	S015181
FUSEConnect® Accessories	
FH-FC-20 (900 μ m within 2.0 mm sheathing) (each)	S014696
FH-FC-30 (900 μ m within 3.0 mm sheathing) (pair)	S014695
FH-FC-900 (900 μ m cable) (each)	S014697
CLAMP-FC-2000 (pair)	S014705
CLAMP-FC-3000 (pair)	S014704

DESCRIPTION	AFL NO.
Power Supply Options	
BTR-17 Battery Pack	S018324
ADC-21 AC Adapter	S018168
ACC-09 Power Cord	S014390
Miscellaneous	
WT-10 Work Tray	S018336
TS-03 Tripod Screw	S017524
ST-03 Carrying Case and Work Tray Strap	S017549
CLAMP-DC-12 drop cable clamp on work tray	S017550
ELCT2-16B Electrodes	S017103
CC-45 Transit Case	S018326
Splicer V-Groove Cleaning Kit	S014397
USB-01 USB Cable	S014777
SP-04 Fiber Holder Set Plates	S018332
AD-16A Adapter Plate (CT-50 and CT-16 up to 900 μ m)	S018328
Portable Tripod Workstation (see web listing for more detail)	S014773

Fujikura 45S Fusion Splicer

Specifications

PARAMETER	VALUE	
Fiber alignment method	Active cladding alignment	
Fiber count can be spliced	Single fiber	
Applicable fiber	Fiber type	Single-mode optical fiber Multimode optical fiber
	Cladding dia.	Approx. 125 μm
Applicable coating	Sheath Clamp	Coating diameter: Max. 3,000 μm Cleave length: 5 to 16 mm ^{*1}
	Fiber Holder	Coating diameter: 160 μm – 3,000 μm based on available fiber holder options Cleave length: Approx. 10 mm
Fiber splice performance	Splice loss ^{*2}	ITU-T G.652: Avg. 0.03dB
		ITU-T G.651: Avg. 0.01dB
ITU-T G.653: Avg. 0.05dB		
ITU-T G.655: Avg. 0.05dB		
ITU-T G.657: Avg. 0.03dB		
Splicing time ^{*3}	SM FAST mode: Avg. 6 to 7 sec.	
	SM AUTO mode: Avg. 8 to 10 sec.	
Applicable protection sleeve	Sleeve type	Heat shrinkable sleeve
	Sleeve length	Max. 66 mm
	Sleeve dia.	Max. 6.0 mm before shrinking
Sleeve heat performance	Heat time ^{*4}	60 mm mode: Avg. 15 to 22 sec.
		60 mm slim mode: Avg. 15 to 17sec.
Fiber tensile test force	Approx. 2.0 N	
Electrode life ^{*5}	Approx. 6,000 splices	
Physical description	Dimensions W	Approx. 131 mm without projection
	Dimensions D	Approx. 123 mm without projection
	Dimensions H	Approx. 121 mm without projection
	Weight	Approx. 1.4 kg including battery
Environmental condition	Temperature	Operate : -10 to 50°C Storage : -40 to 80°C
	Humidity	Operate : 0 to 95% non-condensing Storage : 0 to 95% non-condensing
	Altitude	Max. 5,000 m
AC adaptor	Input	AC100 to 240V, 50/60Hz, Max. 1A
	Output	Approx. DC 19V, Max. 2.1A
Battery pack	Type	Rechargeable Lithium Ion
	Output	Approx. DC 14.4V / 3,190mAh
	Capacity ^{*6}	60 mm heat mode: Approx. 200 splice & heat cycles
		60 mm slim heat mode: Approx. 230 splice & heat cycles
	Temperature	Operate: -10 to 50°C
Recharge : 0 to 40°C		
Short term storage of 30 days: -20 to 50°C Long term storage: -20 to 30°C		
Battery life ^{*7}	Approx. 500 recharge cycles	
Display	LCD monitor	TFT 4.95 inches with touch screen
	Magnification	Approx. 132 to 300X
Illumination	V-grooves	LED lamp
Interface	PC	USB2.0 MINI B type
	External LED lamp	USB 2.0 A type
		Approx. DC5V, 500mA
Wireless ^{*8}	Bluetooth® 5.2	

Fujikura 45S Fusion Splicer

Specifications

PARAMETER		VALUE
Data storage	Splice mode	100 splice modes
	Heat mode	30 heat modes
	Splice result	20,000 splices
	Fiber image	100 images
Screw hole for tripod		1/4-20UNC
Other features	Automatic functions	Fusion control
		Blade management and control
		Splice start
		Heater start
	Reference guide	PDF file stored on splicer
	Sheath clamp	Open with/without wind protector
		Close when setting fiber
		Easy sleeve positioning design
	Electrode	Tool-less replacement
	PC Software	Splicer firmware update via internet
Parameter Upload and download		

NOTES:

- *1 Cleave length range depending on fiber type
 5 – 16 mm: 125 μm cladding dia. And 250 μm coating dia.
 10 – 16 mm: 125 μm cladding dia. And 400 or 900 μm coating dia.
- *2 Measured with cut-back method relevant to ITU-T and IEC standard after splicing Fujikura identical fibers. The average splice loss changes depending on the environmental condition and fiber characteristics.
- *3 Measured at room temperature. The definition of splice time is from the fiber image appearing on the LCD monitor to the estimated splice loss. The average splice time changes depending on the environmental conditions, fiber type, and fiber characteristics.
- *4 Measured at room temperature with the AC adapter. The heat time is defined from the start beep sound to the finish beep sound. The average heat time changes depending on the environmental conditions, sleeve type, and battery pack condition. In addition, since the heating operation is constantly optimized, the average heating time changes depending on the usage conditions of the fusion splicer.
- *5 The electrode life changes depending on the environmental conditions, fiber type, and splice modes used.
- *6 Test Conditions
 Splice and heat time: 1 minute cycle
 Using the splicer power save settings, subject to our testing condition
 Using a new battery
 Room temperature
 The battery capacity changes when testing in different conditions than above
- *7 The battery capacity decreases to half after approx. 500 discharge and recharge cycles. The battery life is shortened further when using outside of the storage and operating temperature ranges, or if completely discharged when stored for an extended period without recharging.
- *8 Bluetooth mark and logos are registered trademarks of Bluetooth SIG, Inc.

SpliceConnect with Tool Kit

AFL's SpliceConnect is a mechanical splice that provides an inexpensive, quick alternative to mating fibers. Using V-groove technology, this splice maintains physical contact between the fibers. An assembly tool is used to ensure the fibers are mated correctly, resulting in <math><0.1\text{ dB}</math> insertion loss (typical for single-mode). The SpliceConnect secures both fiber and coating independently with the U-shaped sleeve, enhancing the strength against fiber twist.



Features

- Quick splicing time
- Minimal tools
- 250 μm and/or 900 μm fiber capabilities
- Both fiber and coating are secured independently

Applications

- Restoration
- Premise environments
- Fiber-to-the-Subscriber (FTTx) applications

Dimensions and Structure

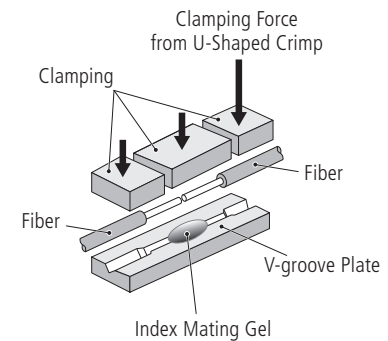
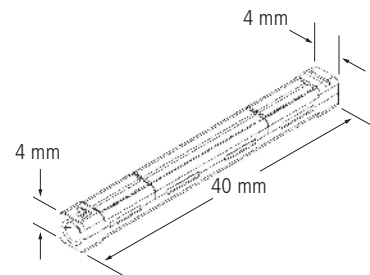

Ordering Information

DESCRIPTION	AFL NO.
SpliceConnect Mechanical Splices (Bag of 6)	CS004154
SpliceConnect Mechanical Splice Tool Kit <i>Kit Includes:</i>	CS004162
SpliceConnect Mechanical Splicing Tool	CS004155
Fiber Holder, 250 μm x2	CS004442
Fiber Holder, 900 μm x2	CS004443
Instruction Manual	CS004159
Carrying Case	CS004161
Template, Strip/Cleave Length	CS004573
SpliceConnect Mechanical Splicing Tool	CS004155
Fiber Holder, 250 μm	CS004442
Fiber Holder, 900 μm	CS004443



eABF Solutions

The eABF® (Enterprise air blown fiber) cabling system is engineered to offer a reliable, easy-to-install optical fiber network communications infrastructure that has one of the highest fiber density solutions in the blown fiber market. The eABF solution has several key elements that, when combined, yield a state-of-the-art and highly flexible “living” communications pathway as shown in the eABF solutions map on the right. Applications include campus settings, military, hospitals, industrial and government.

With its many configurations, the eABF solution can be utilized for expanding your network infrastructure, whether new or retrofit. MicroDuct(s) can be left open to accept a fiber optic cable in the future, for a cost effective way to add bandwidth. Crowded easements, both aerial and buried, can benefit from eABF for network expansion while requiring minimal space and disruption. When it comes to expanding your network, minimize expenditures and maximize capacity with the eABF solution from AFL and Dura-Line.

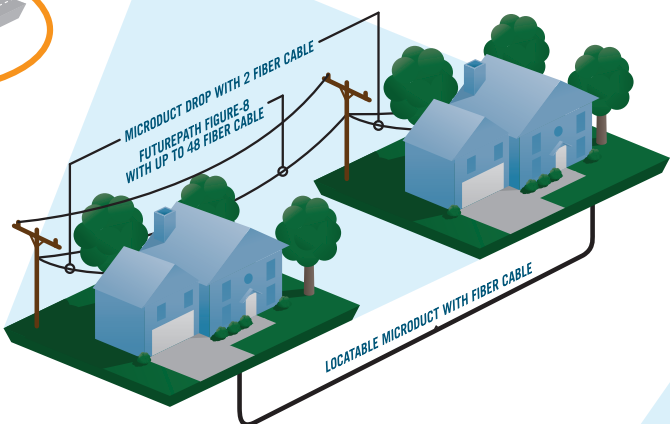
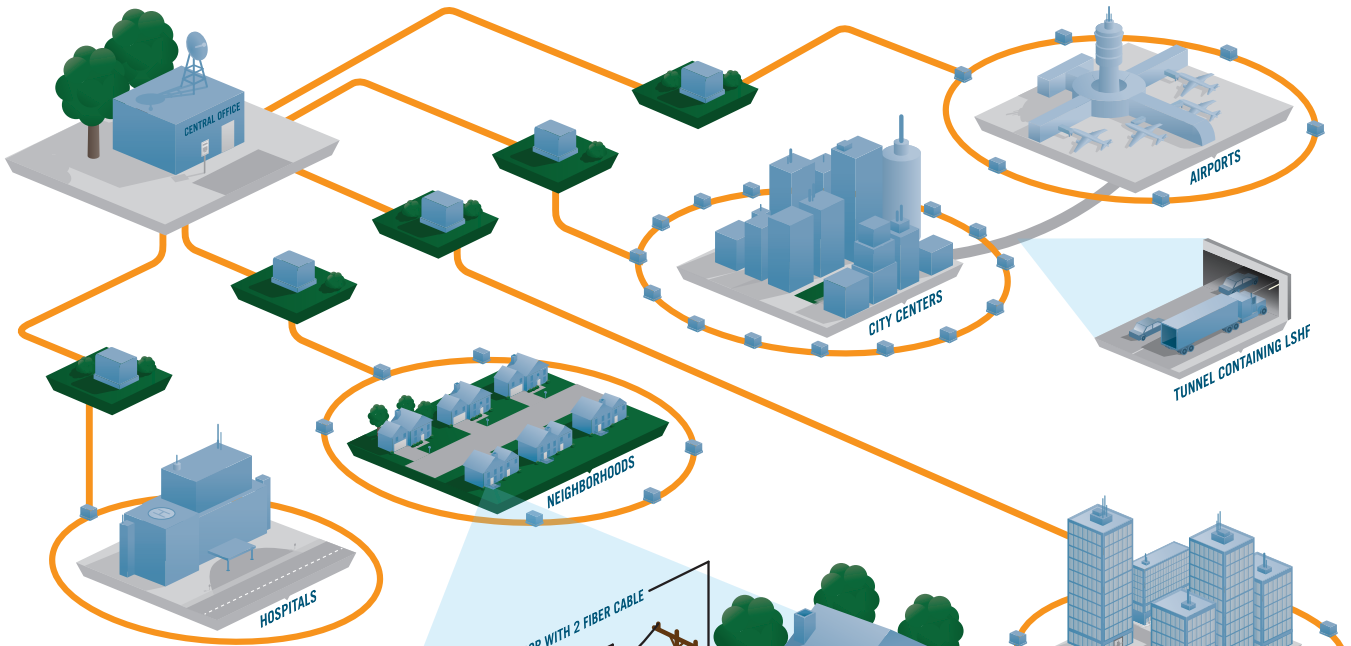

INSIDE PLANT (ISP) ENCLOSURE CONNECTOR

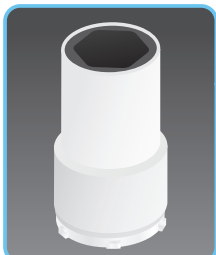

8.5MM STRAIGHT COUPLER

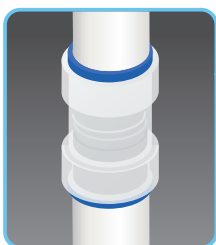

19-WAY RISER WITH FIBER



OUTSIDE PLANT (OSP) ENCLOSURE CONNECTOR



WALL MOUNT BOX

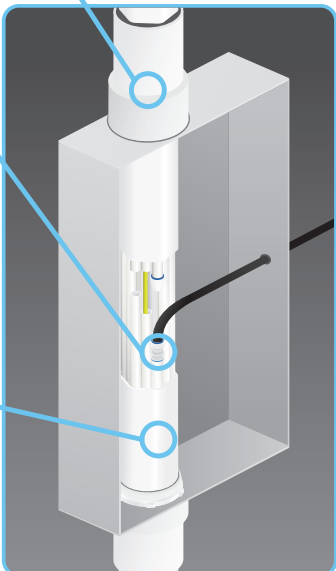

2-WAY PLENUM WITH FIBER

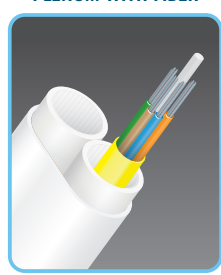

V-20

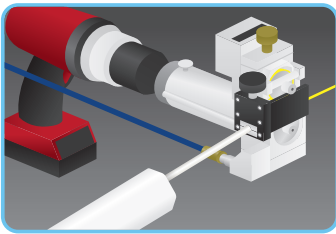

FUTUREPATH WITH FIBER CABLE

